

CATALOGUE

v1.1

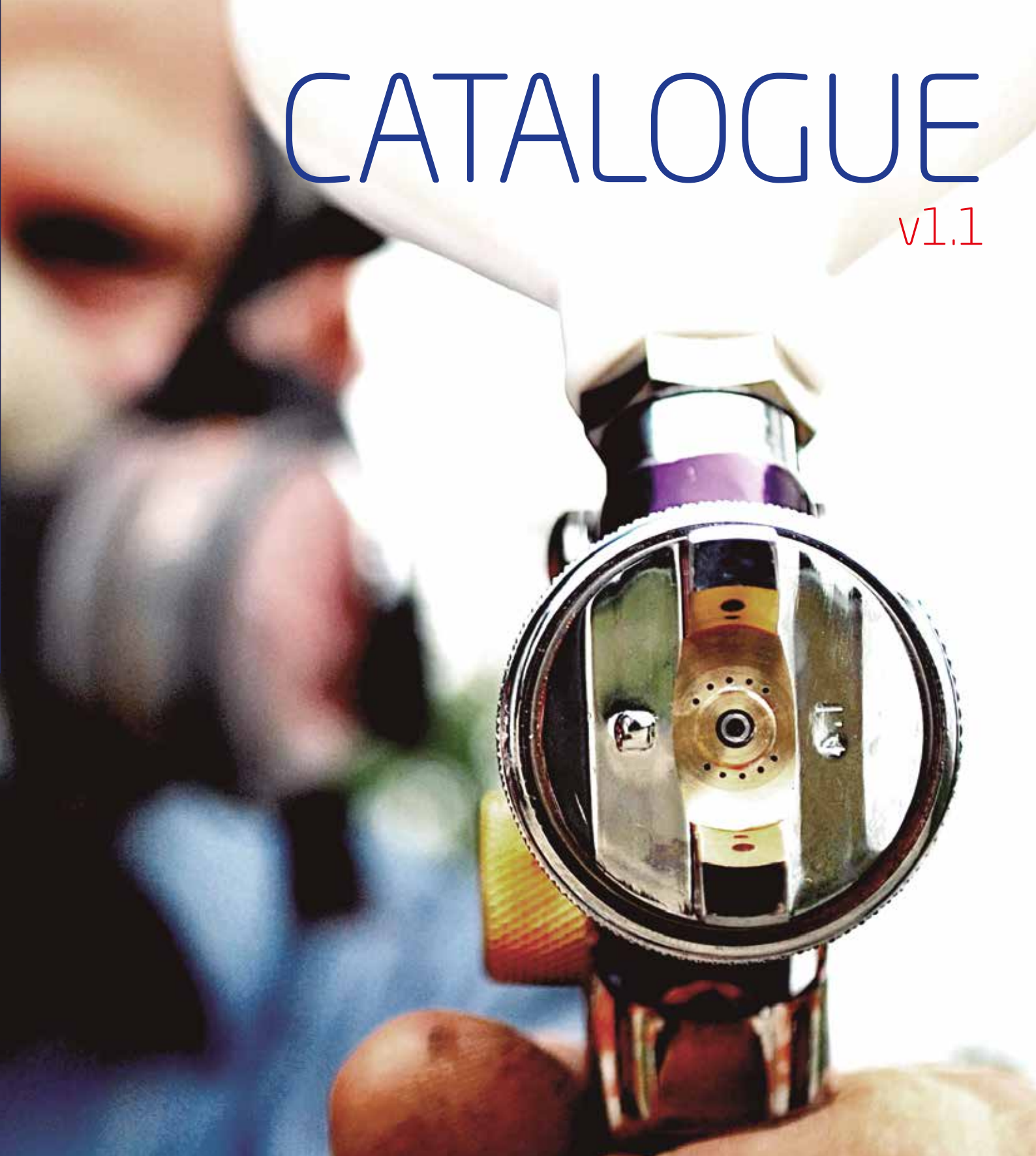

B-TEC[®]



Our mission:

We develop and produce innovative, eco-friendly, ergonomic and high-quality systems and facilities for paint using businesses. We represent optimal working safety and highest customer satisfaction, always with the claim to perfection - worldwide.

Our vision:

Imagine a workplace that is eco- and health-friendly, free from emissions, ergonomic, adaptable to different people, and intuitively operable.

Imagine an equipment partner which reacts immediately to your individual wishes and demands - and puts them into operation. Independent from external shareholders, the customer's satisfaction is our central goal. With constant investment into innovation, coupled with an accessible cost structure, we make the work place of the future already possible, today. Our aspiration is to satisfy the customer as the leading supplier of eco-friendly, ergonomic and high-quality paint equipment - in Germany, Europe and the whole world. True to our motto: Be Better, Be Smart, B-TEC!



We ensure your success.

Highest quality standards | Innovative technology | Maximum customer satisfaction

© jonasginter - Fotolia.com



B-TEC innovations and inventions have been fascinating painters worldwide for many years.

Honoured i.e. with German Federal Prizes, several patents and recognizable by the B-TEC "Progress and Innovation"-seal, B-TEC innovations are in use around the world.

For more information
<https://www.btecsystems.de/innovations>

Content

Gun Washers

Why B-TEC gun washers?	page 8
Neo-Plus-Line	pages 12 - 22
d-800	Dual automatic and manual spray gun washer combination for solvent and water based paint
ud-800	Gun washer combination for solvent or water based paint
S.U.M.O.	Modular gun washer combination
Starter-01 / -02	Universal gun washer
k-800	Gun washer combination for solvent and water based paint
m-800	Manual gun washer
w-800-1 / w-800-2	Manual gun washer for water based paint
In between cleaning stations	pages 24 - 27
Speedbox 1	In between cleaning station for all disposable cup systems
Speedbox 2	In between cleaning station for water based paints
Speedbox 3	Compact and automatic in between cleaning station
Industry-Line	pages 28- 34
K-1200	Washer combination with automatic and manual features
M-1200-1 / M-1200-2	Manual heavy duty washer
M-1200-TW	Manual heavy duty washer with immersion tanks
M-800-TW	Manual washer with immersion tank for small parts
T-1200-1 / T-1200-2	Work station with exhaust air system
Modular design	The modular Industry-Line
RWR-Line	pages 36 - 39
RWR-800-P / -M	Independent system for washing paint agitators - both static and mobile
RWR-800-H	Automatic paint bucket washer
RWR-600-DK	Automatic pressure pot lid washer
Washers for tube connected paint guns	pages 40 - 44
DUPLEX-800	Washer combination for tube connected and gravity paint guns
SR-800	Universal gun washer for rinsing and cleaning of tube connected spray guns
R-800	Gun washer for external cleaning of tube connected spray guns
S-800	Inside rinsing device for tube connected spray guns and tube packages

Custom designs | pages 46- 47
..... Custom made washers for individual applications

Pneumatic exhaust solvent saver, ATEX-Version..... | pages 48- 49

Drying Technology

Infrared dryer..... | pages 52 - 62
IR-B08-Evolution Short wave infrared dryer with 8 gold metallized emitters and reflectors
IR-B03-Evolution Short wave infrared dryer with 3 gold metallized emitters and reflectors
IR-B02-Evolution Short wave infrared dryer with 3 gold metallized emitters and reflectors
IR-B06 / IR-B06-T Short wave infrared dryer
IR-B03 / IR-B03-T Short wave infrared dryer
IR-B02 Short wave infrared dryer
IR-B01-B Short wave infrared dryer
IR-B01 Short wave infrared dryer
ST-01 Paint sample dryer

UV dryer..... | pages 64- 69
UV-01 Ultraviolet dryer
UV-02 Ultraviolet dryer
UV-02-L Ultraviolet dryer
UV-04-L Ultraviolet dryer

Vehicle Lifts

CARRY-LINE..... | pages 70- 77
CARRY-B / -S / -EB Lift with 3.3 tonnes lifting capacity - Surface mounted version or in-ground version
CARRY XL-S / -EB Lift with 3.5 tonnes lifting capacity - Surface mounted version or in-ground version
CARRY TWIN-S / -EB Lift with up to 3.3 tonnes lifting capacity for lifting on wheels or wheel-free - surface mounted version or in-ground version
Carry Twin XL-S / -EB Lift with up to 3.5 tonnes lifting capacity for lifting on wheels or wheel-free - surface mounted version or in-ground version
CARRY SWING..... Mobile car tilting lift with up to 3.0 tonnes lifting capacity
PR-02 / PR-03 Pneumatic wheel jack

Content

Solvent Recyclers

Convincing reasons why to choose B-TEC solvent recyclers	pages 78
SD-Line	pages 79
SD-15 / -20 / -30 / -50 / -70 / -120 / -200	Distiller for recycling of contaminated solvent and water

Working Tables

Working Tables	pages 80 - 87
PAINTY 01	Mixing and preparation table
PAINTY-02 / Painty -03	Mixing and preparation table with exhaust air system
PAINTY-04	Mixing and preparation table with base cabinet and exhaust air system
AS-600/AS-B/AS-1200/AS-1200-E/AS-E	Modular working table design

Paint Equipment

Water based paint cleaning fluids	pages 90 - 93
H₂O-CLEANER-RK	Water based paint cleaner concentrate
H₂O-CLEANER-RTM	Water based paint cleaner "ready to mix" for manual cleaning
H₂O-CLEANER-RTU	Water based paint cleaner "ready to use"

Storage systems..... | pages 94 - 99

JUMBO-01	Mobile storage system
JUMBO-02	Wall mounted storage system
DEPOT	Mobile storage system
MA-01	Mobile storage system
EA 500 / 700	Corner shelf for spray booths

Other equipment..... | pages 100 - 107

SUNNY-LED	LED-Daylight lamp with adjustable stand
JIMMY	The polishing butler
UST-110	Universal paint table
TWISTER	Mobile rotatable paint table
SPEED-DRYER	Mobile air blowing system
RST-01	Collecting container for waste paint
RST-05	Blow-out station
CM-900	Coagulation powder
CS-300	Coagulation kit
MD-02	Space-saving paint stand to be stored on a wall
PH-01	Paper roll holder
STS-18	Mobile solvent transfer station

B-TEC spray gun and parts washers components

Washer	Neo-Plus-Line								In-between cleaning stations			Industry-Line			Tube connected spray guns			
	d	ud	m	k	w	SUMO	STARTER		SPEED BOX			K	M	M	Duplex	SR	R	S
Components	800						01	02	1	2	3	1200	1200-TW	800				
Paint guns at the same time	4-6	2-3	1	2	1	2	1	1	1	1	1	2	1-2	1	2	1	1	1
Cleaning area made of stainless steel	•	•	•	•	•	•	•	•	•	•	•	•	•	•	•	•	•	•
Ergonomic front access	•	•	•	•	•	•	•	•	•	•	•	•	•	•	•	•	•	•
Number of pumps	6	3	1	4	1	0-6	2	1	•	1	1	3	1-2	1	2-6	1	1	•
Efficient and effective exhaust air system	•	•	•	•	•	•	•	•	•	•	•	•	•	•	•	•	•	•
Wall mounting possible	•	•	•	•	•	•	•	•	•	•	•	•	•	•	•	•	•	•
Safety feature on washer door	•	•	•	•	•	•	•	•	•	•	•	•	opt.	•	•	•	•	•
Solvent	•	•	•	•	•	•	•	•	•	•	•	•	•	•	•	•	•	•
Water based paints	•	•	•	•	•	•	•	•	•	•	•	•	•	•	•	•	•	•
Recirculated cleaning fluids	•	•	•	•	•	•	•	•	•	•	•	•	•	•	•	•	•	•
Fresh cleaning fluids	•	•	•	•	•	•	•	•	•	•	•	•	•	•	•	•	•	•
Automatic cleaning	•	•	•	•	•	•	•	•	•	•	•	•	•	•	•	•	•	•
Automatic cleaning with timer	•	•	•	•	•	•	•	•	•	•	•	•	•	•	•	•	•	•
Sealed air channels with automatic air purge	•	•	•	•	•	•	•	•	•	•	•	•	•	•	•	•	•	•
Simultaneous automatic and manual cleaning	•	•	•	•	•	•	•	•	•	•	•	•	•	•	•	•	•	•
Automatic clean rinse with fresh cleaning fluid	•	•	•	•	•	•	•	•	•	•	•	•	•	•	opt.	•	•	•
Manual cleaning with through-flow brush	•	•	•	•	•	•	•	•	•	•	•	•	•	•	opt.	•	•	•
Manual cleaning with fresh cleaning fluid	•	•	•	•	•	•	•	•	•	•	•	•	•	•	•	•	•	•
Blow-out feature with integrated exhaust air system	•	•	•	•	•	•	•	•	•	•	•	•	•	•	•	•	•	•
All features individually adjustable	•	•	•	•	•	•	•	•	•	•	•	•	•	•	•	•	•	•
Movable overflow bund	2	1	1	1	opt.	opt.	opt.	opt.	•	•	•	1	1	1	opt.	•	•	•

B-TEC washer guide

Kind of spray gun	Gravity gun								Tube connected spray gun	Gravity and tube connected spray gun
Kind of paint	Water based and solvent based paints		Water based or solvent based paints				Water based paint		Water based or solvent based paint	Water based and/or solvent based paints
Kind of cleaning	Simultaneous automatic and manual cleaning	Automatic and manual cleaning	Simultaneous automatic and manual cleaning	Automatic and manual cleaning	Automatic cleaning	Manual cleaning	Automatic cleaning	Manual cleaning	Automatic cleaning	Automatic und manual cleaning
Washer	d-800	k-800	K-1200 ud-800	Starter-01	Speedbox 3	M-1200 m-800 Starter-02 Speedbox 1 M-1200-TW	Speedbox 2	w-800	SR-800 R-800 S-800	Duplex-800
S.U.M.O										



Gun Washers

Why B-TEC gun washers?

- use of the latest KALREZ® - pump technology
- automatic cleaning by 9 to 11 cleaning nozzles per washer
- cleaning of your paint and spray guns at 100 %
- opening the spray / paint guns by a trigger clamp takes place inside the gun washer after the gun sits perfectly on the cleaning nozzle. Solvent or paint behind the air cap is prevented!
- no disassembling of the air cap required - less mechanical damage to the paint / spray gun and high time savings
- bright cleaning chambers due to the utilization of stainless steel
- no utilization of light absorbing plastic
- optimal viewing conditions inside the washer without inconvenient glass plates or bezels
- ergonomic and fast cleaner change due to moveable overflow bunds. No laborious removing of any frames or similar is necessary!
- powerful exhaust air system in all B-TEC washers to be used with solvent
- 100 % »Made in Germany«
- B-TEC gun washers have been approved by leading world-renowned spray gun manufacturers for many years!



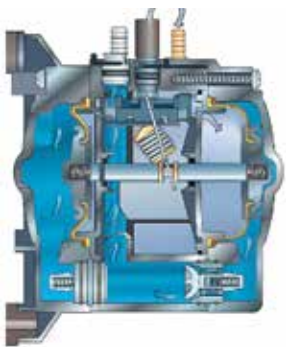

KALREZ® pump technology

Double diaphragm pump with ATEX-certification

B-TEC machines use pumps with double diaphragms made from perfluoroelastomer Kalrez (FFKM). These pumps can supply up to almost 19 litres flow per minute supported by a unique design of check valves with Viton® Extreme (TM) seals.

The superb sealings and diaphragms resist over 1800 different chemicals. The body is constructed of a corrosion resistant material to withstand the toughest working conditions - like all components of our spray gun washers!

Neo-Plus-Line

In between cleaning stations

Industry-Line

RWR-Line

Washers for tube connected paint guns

Custom designs

Pneumatic exhaust solvent saver

Spray gun and parts washers components in detail

- 01 Washer flap with automatic exhaust air activation
- 02 Manual cleaning by fresh cleaning fluid
- 03 Manual cleaning by fully adjustable brush with recirculating cleaning fluid and double diaphragm pump
- 04 Two independent automatic cleaning compartments with 11 spray nozzles in each room for automatic spray gun cleaning, two independent manual cleaning rooms - simultaneous automatic and manual cleaning is possible.
- 05 Spray gun holder including spray nozzle
- 06 Gun cup holder
- 07 Air blow gun including quick connector
- 08 Drain hose
- 09 Two moveable safety overflow bunds with a capacity of 4 x 60 litre drums

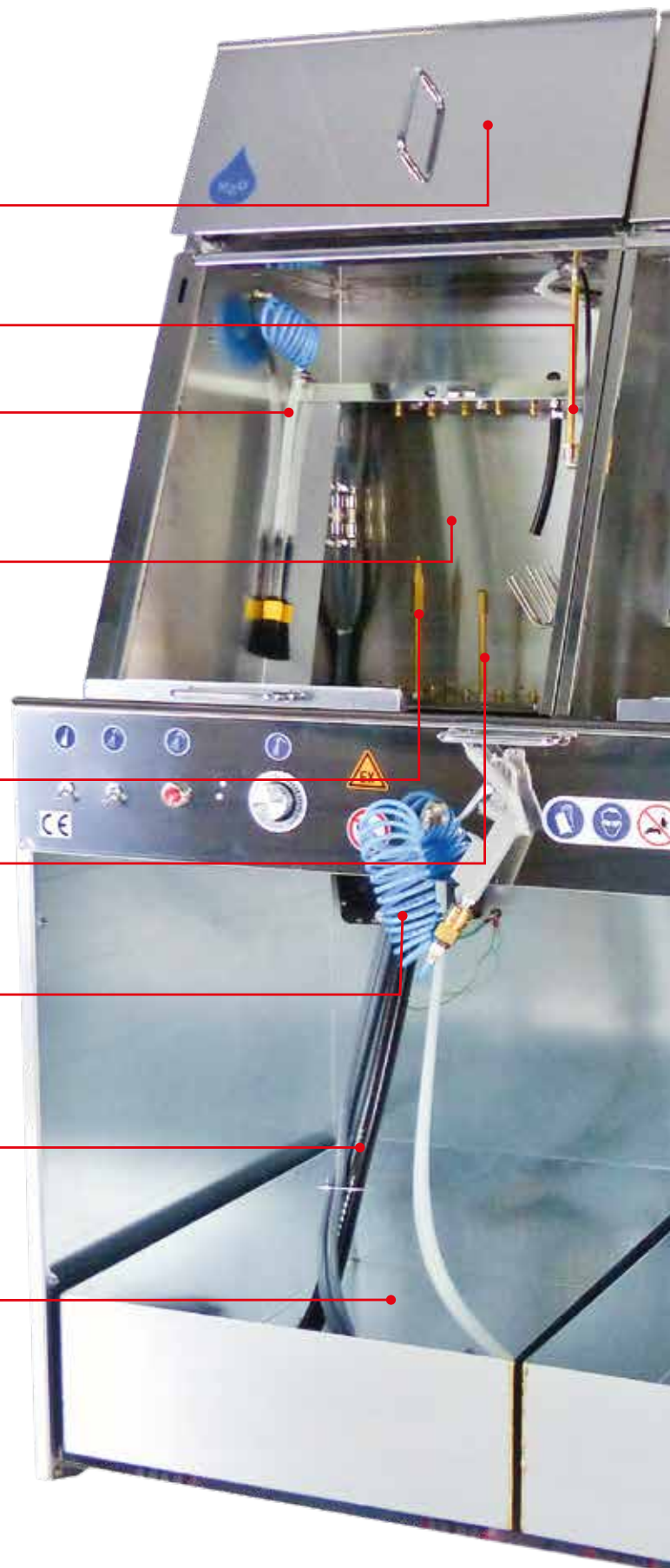

▲ d-800

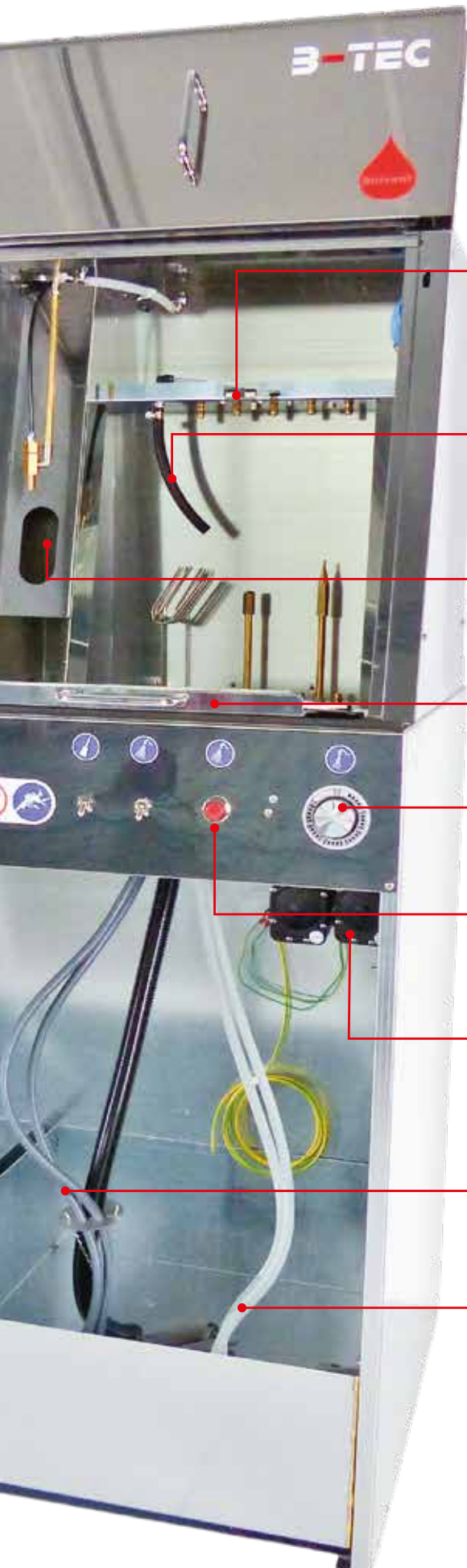
**10**

Safety feature with automatic shut down

11

Air channel sealing with automatic air purge

12

Efficient exhaust air system with blow out feature

13

Door for automatic cleaning room

14

Automatic cleaning with timer

15

Automatic clean rinse with fresh cleaning fluid

16

Cleaning is powered by three double diaphragm pumps for each washer side

17

Suction hose with stainless steel filter for recirculated cleaning fluid

18

Suction hose with stainless steel filter for fresh cleaning fluid





Neo-Plus-Line

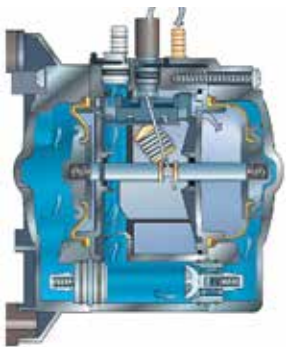

KALREZ® pump technology

Double diaphragm pump with ATEX-certification

B-TEC machines use pumps with double diaphragms made from perfluoroelastamer Kalrez (FFKM). These pumps can supply up to almost 19 litres flow per minute supported by a unique design of check valves with Viton Extreme (TM) seals.

The superb sealings and diaphragms resist over 1800 different chemicals. The body is constructed of a corrosion resistant material to withstand the toughest working conditions - like all components of our spray gun washers!

d-800

ud-800

S.U.M.O.

Starter-01 / -02

k-800

m-800

w-800-1 / w-800-2



d-800

Dual automatic and manual spray gun washer combination for solvent and water based paint

Art-No. 10000550



Specifications

- **Automatic and manual cleaning at the same time**
- for solvent and B-TEC-H₂O-Cleaners
- pump driven through-flow brush with recirculated cleaning fluid
- manual clean rinse with fresh cleaning fluid
- overspray containment room with exhaust air channel
- efficient exhaust air system
- automatic cleaning with timer
- **including automatic clean rinse**
- pressurized air purge system protects spray guns during the automatic cleaning process
- brilliant cleaning results - 12 spray nozzles each side
- ergonomically designed construction allows convenient front operation
- all features fully adjustable
- air connector with air blow gun
- two overflow bunds on rollers (30 L, 58 L, 60L barrels possible)
- **options:** 2 guns in one cleaning room;
Pneumatic exhaust solvent saver, ATEX-Version

Dimensions

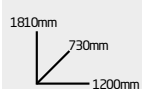



ud-800

Gun washer combination for
solvent or water based paint

Art-No. 10000552



Specifications

- **Automatic and manual cleaning at the same time**
- for solvents or B-TEC-H₂O-Cleaners
- pump driven through-flow brush with recirculated cleaning fluid
- manual clean rinse with fresh cleaning fluid
- overspray containment room with exhaust air channel
- efficient exhaust air system
- automatic cleaning with timer
- **including automatic clean rinse**
- pressurized air purge system protects spray guns during the automatic cleaning process
- brilliant cleaning results
- ergonomically designed construction allows convenient front operation
- all features fully adjustable
- air connector with air blow gun
- overflow bund on rollers (30 L, 58 L, 60L barrels possible)
- **options:** 2 guns in one cleaning room;
Pneumatic exhaust solvent saver, ATEX-Version

Dimensions



Set Up My Own

Modular gun washer combination,
the latest universal gun washer
generation



Two large cleaning compartments
made of stainless steel.



For solvent and/or B-TEC-H2O-Cleaner.



Individual and independent
configuration of both cleaning rooms
possible.

< Possible configuration left side



Module 1
Pump driven through-flow brush



Module 2
Manual clean rinse



Module 3
Automatic spray gun cleaning with timer,
sealing air purge system and 9 nozzles



Module 4
Automatic clean rinse
(only in connection with module 3)

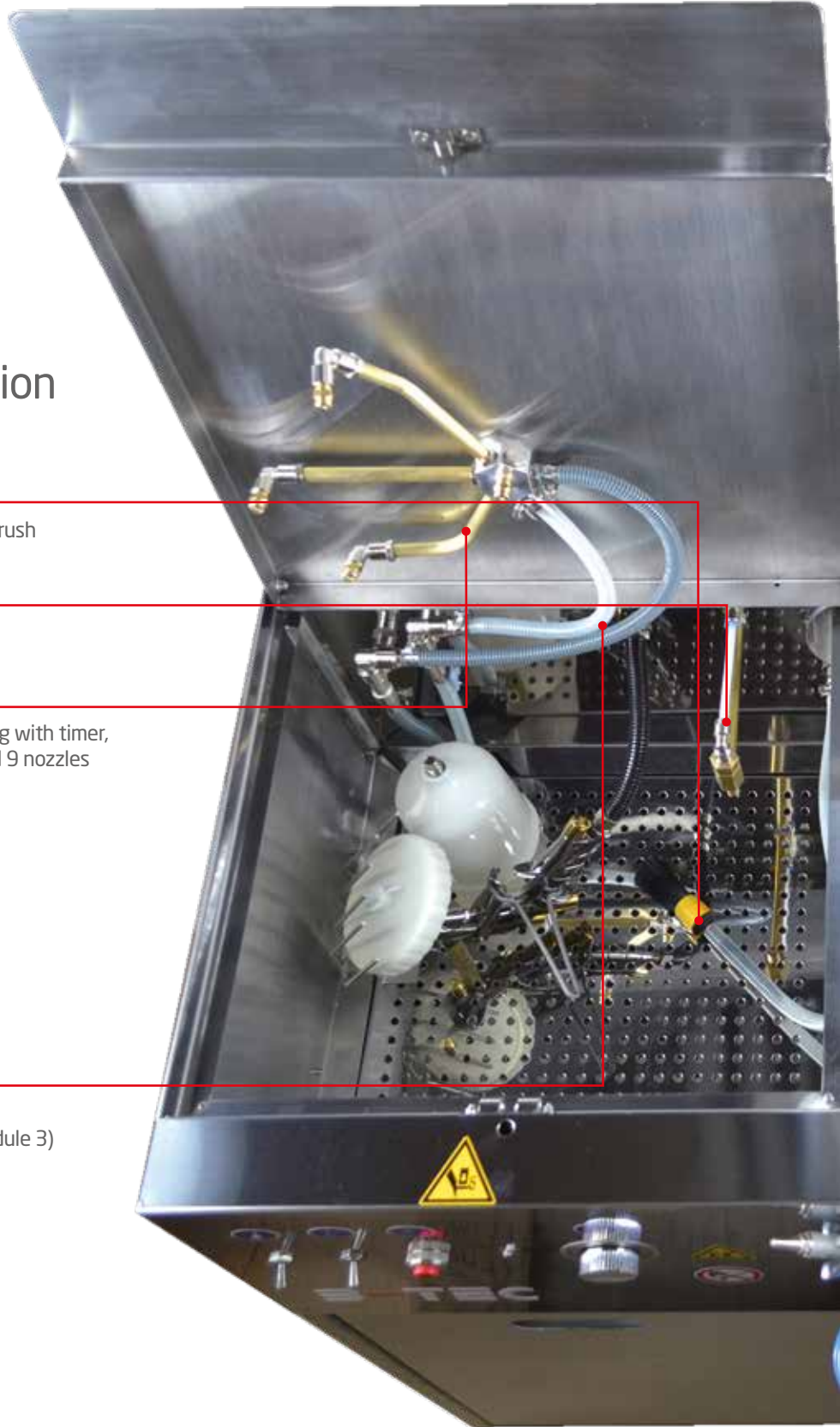



Double diaphragm pumps with latest Kalrez technology



Including air blow gun



Safety feature with automatic shut down



Powerful exhaust air system



All features fully adjustable



Space for up to four 30 L barrels, rollable overflow bund option



Possible configuration > **right side**



Module 5
Pump driven through-flow brush



Module 6
Manual clean rinse



Module 7
Automatic spray gun cleaning with timer, sealing air purge system and 9 nozzles



Module 8
Automatic clean rinse
(only in connection with module 3)

Module 9
Base with door (galvanized)



S.U.M.O.

Modular gun washer combination

Art-No. 10000513
(Completely equipped)



Specifications

- Robust construction - wall installation possible
- basic module made of stainless steel
- basic module including powerful exhaust air system and air blow gun
- two large cleaning compartments
- pressurized air purge system protects spray guns during the automatic cleaning process
- individual and independent configuration of both cleaning compartments with:
 - automatic cleaning with timer
 - automatic clean rinse
 - pump driven through-flow brush with recirculated cleaning fluid
 - manual clean rinse with fresh cleaner
- for solvents or B-TEC H₂O-Cleaner
- **options:**
 - Pneumatic exhaust solvent saver, ATEX-Version
 - overflow bund on rollers

Dimensions with optional base





Starter-01 Starter-02

Starter-01 - automatic + manual
Starter-02 - manual

Art-No. 10000547 / 10000548



Specifications

- Robust construction - wall installation possible
- for automatic and manual cleaning
- efficient exhaust air system
- cabinet and cleaning-relevant parts made of stainless steel
- pump driven through-flow brush with recirculated cleaning fluid
- manual clean rinse with fresh cleaning fluid
- for solvents or B-TEC-H₂O-Cleaners
- pressurized air purge system protects spray guns during the automatic cleaning process
- **Starter-02** - manual gun washer, like Starter-01 but without automatic cleaning
- **options:**
 - base cabinet with door, galvanized
 - Pneumatic exhaust solvent saver, ATEX-Version



▲ Option: Geräteunterbau verzinkt

Dimensions





k-800

Gun washer combination for solvent and water based paint

Art-No. 10000546



Specifications

- Left side for manual cleaning of water based paints, right side for automatic and manual cleaning of solvent based paints
- space saving - only 1200 mm wide
- brilliant cleaning results
- easy handling
- including coagulation kit and filters
- ergonomically designed construction allows convenient front operation
- all cleaning-relevant parts made of stainless steel
- all features fully adjustable
- includes door for the base
- **automatic clean rinse on the solvent side**
- overflow bund on rollers (30 L, 58 L, 60L barrels possible)
- **option:** Pneumatic exhaust solvent saver, ATEX-Version

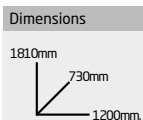



m-800

Manual gun washer

Art-No. 10000543



Specifications

- Large work space for manual cleaning
- efficient exhaust air system
- pump driven through-flow brush with recirculated cleaning fluid
- manual clean rinse with fresh cleaning fluid
- all cleaning-relevant parts made of stainless steel
- ergonomically designed construction allows convenient front operation
- for solvent or B-TEC-H₂O-Cleaners
- air connector with air blow gun
- all features fully adjustable
- overflow bund on rollers (30 L, 58 L, 60L barrels possible)
- **option:** Pneumatic exhaust solvent saver, ATEX-Version

Dimensions

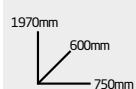



w-800-1 w-800-2

Manual gun washer
for water based paint

Art-No. 10000544 / 10000545



Specifications

- All cleaning-relevant parts made of stainless steel
- ergonomically designed construction allows convenient front operation
- splash guard
- pump driven through-flow brush with recirculated cleaning fluid
- rinse gun
- pneumatic coagulation device
- air connector with air blow gun
- including coagulation kit and filters
- **w-800-2** - without pumps for on site water connection
- **option:** door for the base

Dimensions







In between cleaning stations

SPEEDBOX 1

SPEEDBOX 3

SPEEDBOX 2



SPEEDBOX 1

In between cleaning station for all
disposable cup systems

Art-No. 10000925



Specifications

- Compact device for wall installation
- rapid colour change and manual internal cleaning of spray guns using disposable cups
- including exhaust air system with overspray containment room
- made of stainless steel
- installation inside and outside of the spray booth possible due to exhaust air system
- all features fully adjustable
- no fluids can soak into filter pads
- for all paint and paint cup systems
- storage space for up to 4 cups

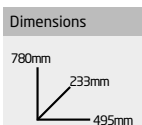



SPEEDBOX 2

In between cleaning station for water based paints

Art-No. 1000926



Specifications

- Compact device for wall installation
- for automatic internal cleaning of spray guns
- cleaning inside a closed-loop system
- pressurized air purge system protects spray guns during the automatic cleaning process - removal of air caps not necessary
- only for water based paints
- designed to be used with disposable cup systems inside the spray booth
- significantly better cleaning results compared to manual in between cleaning stations
- no contamination of filter pads as cleaning fluids are used recirculated
- brilliant cleaning results if used with B-TEC-H₂O-Cleaners
- recirculated cleaner - lower cleaner consumption



Dimensions





SPEEDBOX 3

Compact and automatic in between cleaning station

Art-No. 10000927



Specifications

- **Probably the world's smallest gun washer - with highest user friendliness**
- **automatic internal and external spray gun cleaning**
- for solvents outside the spray booth, for water based cleaning fluids inside the spray booth
- spray gun cleaning including cup and lid
- efficient exhaust air system
- pressurized air purgesystem protects spray guns during the automatic cleaning process - removal of air caps not necessary



Dimensions

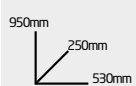



Industry-Line

K-1200

M-800-TW

M-1200-1 / M-1200-2

T-1200-1 / T-1200-2

M-1200-TW

Modular design



Art-No. 10000480

K-1200

Washer combination with automatic and manual features



Specifications

- **Two separate gun washer in one cabinet**
- two separate closed-loop cleaning systems
- shortest cleaning process with excellent results
- efficient exhaust air system
- automatic and manual cleaning in one cabinet
- pressurized air purge system protects spray guns during the automatic cleaning process
- ergonomically designed construction allows convenient front operation
- modular concept saves space and enables easier handling
- overflow bund on rollers
- for solvent or B-TEC-H₂O-Cleaners
- all features fully adjustable
- **option:** Pneumatic exhaust solvent saver, ATEX-Version

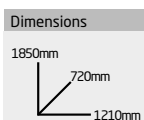



▲ M-1200-1

M-1200-1 M-1200-2

Manual heavy duty washer

Art-No. 10000478 / 10000479



Specifications

- The large work space enables parts up to 1200 mm long to be cleaned
- all features fully adjustable
- pump driven through-flow brush with recirculated fluid
- manual clean rinse with fresh fluid
- efficient exhaust air system
- low solvent consumption
- for solvent or B-TEC-H₂O-Cleaners
- **M-1200-2** - two brushes and two manual clean rinses for two painters at the same time
- **options:**
 - stainless steel flap with automatic air exhaust activation (prevents dust ingress)
 - Pneumatic exhaust solvent saver, ATEX-Version



▲ M-1200-2

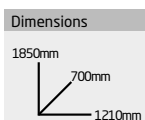



M-1200-TW

Manual heavy duty washer
with immersion tanks

Art-No. 10000474



Specifications

- Manual heavy duty gun washer with two immersion tanks and two baskets
- compact washer combination for immersion and washing
- for solvent or B-TEC-H₂O-Cleaners
- stainless steel flap with automatic exhaust air activation (prevents dust ingress)
- two immersion tanks (each 250 x 400 x 250 mm)
- two immersion baskets
- set of basket grippers
- two removable tank covers made of stainless steel
- one 3/4" drain tap each tank
- manual cleaning station with pump driven and adjustable through-flow brush
- one blow gun with air hose
- manual clean rinse with fresh cleaner
- overflow bund on rollers and door included
- exhaust air hose
- **option:** Pneumatic exhaust solvent saver, ATEX-Version

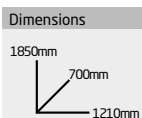



M-800-TW

Manual washer with immersion tank
for small parts

Art-No. 100001016



Specifications

- manual, space saving washer with one immersion tank and basket
- for solvent or B-TEC-H₂O-Cleaners
- stainless steel flap with automatic exhaust air activation (prevents dust ingress)
- dimensions immersion tank: 240 x 240 x 130 mm (LxWxH incl. basket)
- one blow gun with air hose
- overflow bund on rollers and door included
- exhaust air hose
- **options:**
 - through-flow brush with pump
 - manual clean rinse
 - Pneumatic exhaust solvent saver, ATEX-Version

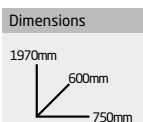



▲ T-1200-1

T-1200-1 T-1200-2

Work station with exhaust air system

Art-No. 10000481 / 10000482



Specifications

- Large work station with powerful B-TEC exhaust air system for handling paints and/or solvents
- for the preparation of paint and spray guns
- keeps your workplace organized and reduces the VOC-values
- **T-1200-1** - overflow bund on rollers and door included
- **T-1200-2** - two stable storage shelves made of stainless steel
- **options:**
 - stainless steel flap with automatic air exhaust activation (prevents dust ingress)
 - Pneumatic exhaust solvent saver, ATEX-Version



▲ T-1200-2

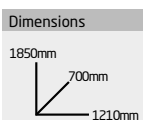



Modular design

The modular Industry-Line



Specifications

- All Industry-Line products can be combined perfectly and functionally
- design enables the user to create the set-up needed to meet their requirements
- all units are made of stainless steel
- developed for toughest operating conditions
- all Industry-Line products can be used with solvent and/or water based paints
- Gun washers, work tables and other accessories from B-TEC can be combined individually and are perfectly matched in their dimensions - saves space with optimized functionality!



B-TEC

B-TEC

B-TEC

B-TEC





RWR-Line

RWR-800-P / -M

RWR-600-DK

RWR-800-H



▲ RWR-800-P

Art-No. 10000476 / 10000475



RWR-800-P / -M

System independant stationary or mobile washer for paint agitators

Specifications

- **Cleaning fluid and time savings of up to 75%***
- stationery (RWR-800-P) or mobile (RWR-800-M)
- shortest cleaning process with excellent results
- efficient exhaust air system
- clean work place
- closed-loop system
- meets ATEX-regulations
- for solvent or B-TEC-H₂O-Cleaners
- all features fully adjustable
- **option:** Pneumatic exhaust solvent saver, ATEX-Version

* depending on what fluid is used and degree of contamination



▲ RWR-800-M



Dimensions RWR-800-P
820mm
600mm
ca. 795mm

Dimensions RWR-800-M
710mm
712mm
720mm





RWR-800-H

Automatic paint pail washer

Art-No. 10000931



Specifications

- **Easy, quick, clean**
- depending on the material used, disposal as non-hazardous waste possible
- shortest cleaning process with excellent results
- efficient exhaust air system
- clean work place
- closed-loop system
- meets the ATEX-regulations
- for solvent or B-TEC-H₂O-Cleaners
- all features fully adjustable
- **option:** Pneumatic exhaust solvent saver, ATEX-Version

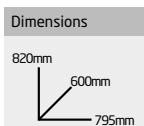



RWR-600-DK

Automatic pressure pot lid washer

Art-No. 10000982



Specifications

- Automatic washer for pressure pot lids, connected tubes and spray guns
- minimum cleaning time with excellent results
- internal and external cleaning of the spray gun, external cleaning of suction pipe and underside of the pressure pot lid
- including blow out feature for emptying the tubes of paint and fluid residues
- including base with door
- efficient exhaust air system
- clean work place
- meets the ATEX-regulations
- for solvent or B-TEC-H₂O-Cleaners
- all features fully adjustable
- **option:** Pneumatic exhaust solvent saver, ATEX-Version



Dimensions



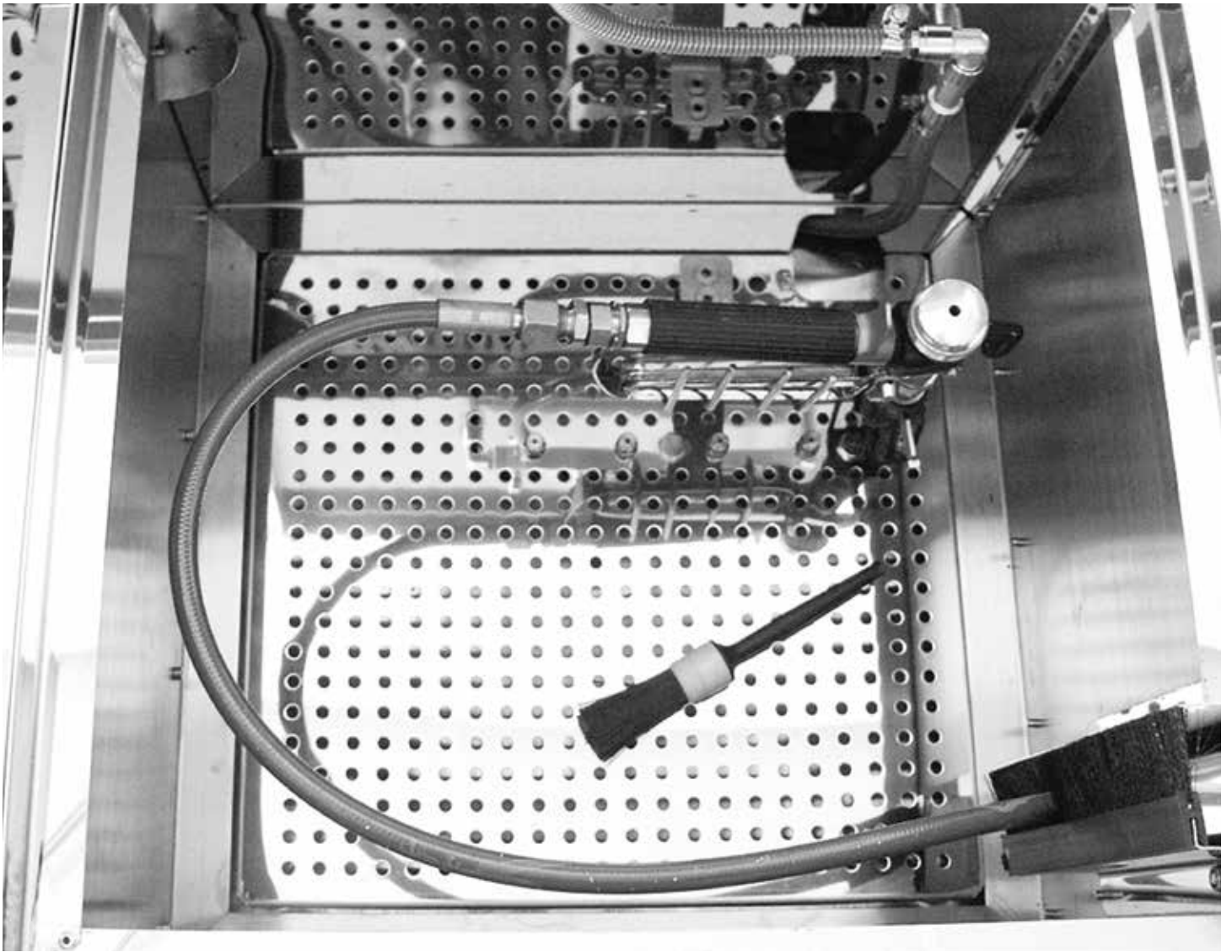

▲ Washers for
tube connected
paint guns

Duplex-800

R-800

SR-800

S-800



Duplex-800

Washer combination for tube connected
and gravity paint guns

Art-No. 10000675



Specifications

• Left side:

- internal and external gravity gun cleaning with
 - automatic cleaning with timer
 - pressurized air purge system protects spray guns during the automatic cleaning process
 - manual clean rinse

• right side:

- external cleaning with timer for tube connected spray guns
- made of stainless steel (base galvanized)
- both sides for solvents or B-TEC-H₂O-Cleaners
- air connector with air blow gun (included)
- efficient exhaust air system
- **options:**
 - pump driven through-flow brush with recirculated cleaner
 - automatic clean rinse
 - overflow bund on rollers
 - Pneumatic exhaust solvent saver, ATEX-Version

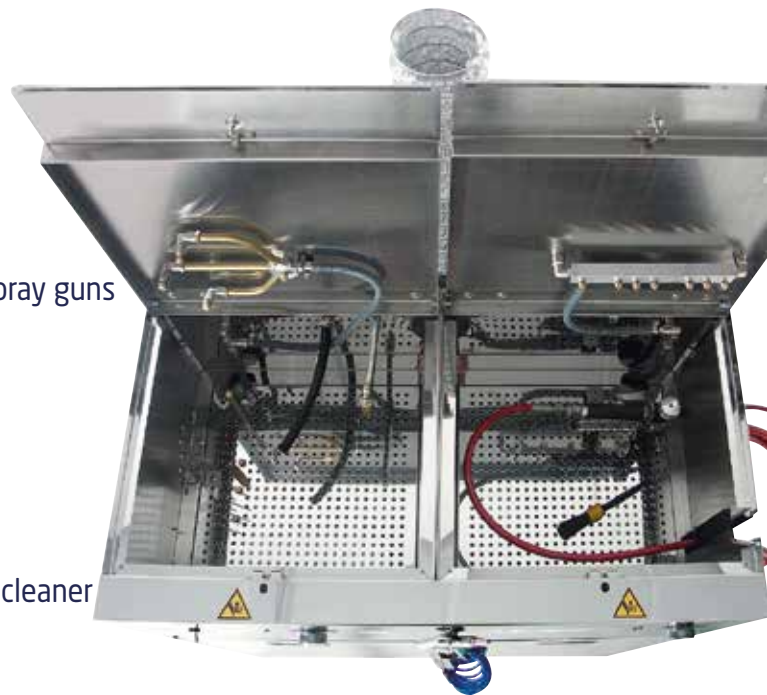

Dimensions





SR-800

Universal gun washer for rinsing and
cleaning of tube connected spray guns

Art-No. 10000670



Specifications

Rinsing and cleaning of tube connected spray guns e.g. airless, airmix or pressure spray guns.

- for solvents or B-TEC-H₂O-Cleaners
- rinsing of tubes and spray guns while exhaust air system is working
- collection of remaining paint and solvent in a separate container without overspray
- automatic external cleaning of spray guns with the help of two nozzle manifolds and recirculated cleaner
- no overspray during cleaning and rinsing of spray guns
- no open container - reduces the VOC-values and fire hazard
- reduced cleaning fluid consumption
- ATEX - compliant
- delivery including base and container for remaining paint
- **option:** Pneumatic exhaust solvent saver, ATEX-Version

Dimensions





R-800

Gun washer for external cleaning
of tube connected spray guns

Art-No. 10000673



Specifications

**Innovative and universal - the latest gun washer generation
for tube connected spray guns.**

R-800 - setting new cleaning standards for

- **airless- and airmix-spray guns**
- **pressure spray guns**

the R-800 is characterised by

- compact design
- efficient exhaust air system
- for solvents or B-TEC-H₂O-Cleaners
- external cleaning of tube connected spray guns and their tube packages
- automatic cleaning with timer
- perfect storage station for cleaning during an operator's break
- **option:** Pneumatic exhaust solvent saver, ATEX-Version



Dimensions



Uncovered, unhealthy and risky
cleaning containers are a thing of
the past, now!



S-800

Internal rinsing device for tube
connected spray guns and tube
packages

Art-No. 10000674



Specifications

- Solvents or water based cleaners are used in a closed-loop system
- very high fluid savings
- usable with all different pumping systems
- moveable and height adjustable stand

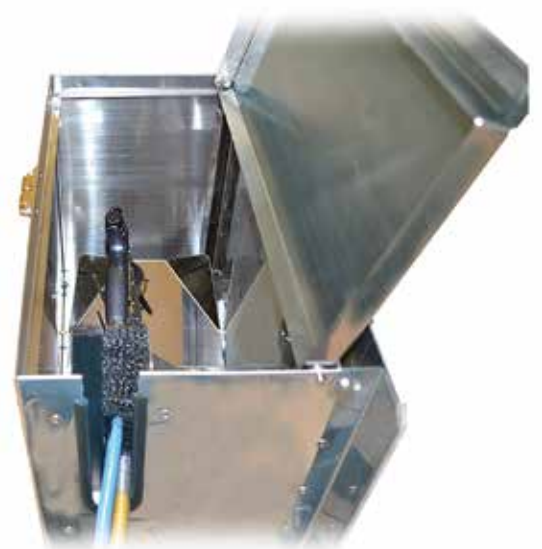

Dimensions



Rinsing device







Custom designs

Custom made washers for individual applications

The B-TEC Gun Washer Series offers a wide product range as the result of many years of development. Adapted to meet the needs of its users, B-TEC machines provide both practical and economic operating solutions.

Nevertheless, there are still specific requirements B-TEC meets with custom designs - please do not hesitate to contact us!

Customised.

Adapted to your individual needs.



Examples of custom designs already in use.

Find further examples on www.btecsystems.de/custom-design



▲ M-1200-WP - Washer for high-rotation atomizers



▲ Paint stripping tanks with baskets



▲ Air cap cleaner LR-800 for automatic spray guns



Pneumatic exhaust solvent saver

ATEX-Version



▲ Pneumatic exhaust solvent saver

ATEX-Version

Art-No. 10001115 (60 mm),
10000347 (100 mm), 10000348 (125 mm)



Specifications

Exhaust solvent saver to prevent solvent loss by connecting B-TEC washers to local exhaust air systems

- Compatible with all B-TEC washers with exhaust air systems
- opens and closes automatically while using the washer
- ATEX-version
- available in 125 mm, 100 mm and 60 mm duct diameters
- easy installation
- if ordered together with a B-TEC washer, slider will already be pneumatically connected to the washer



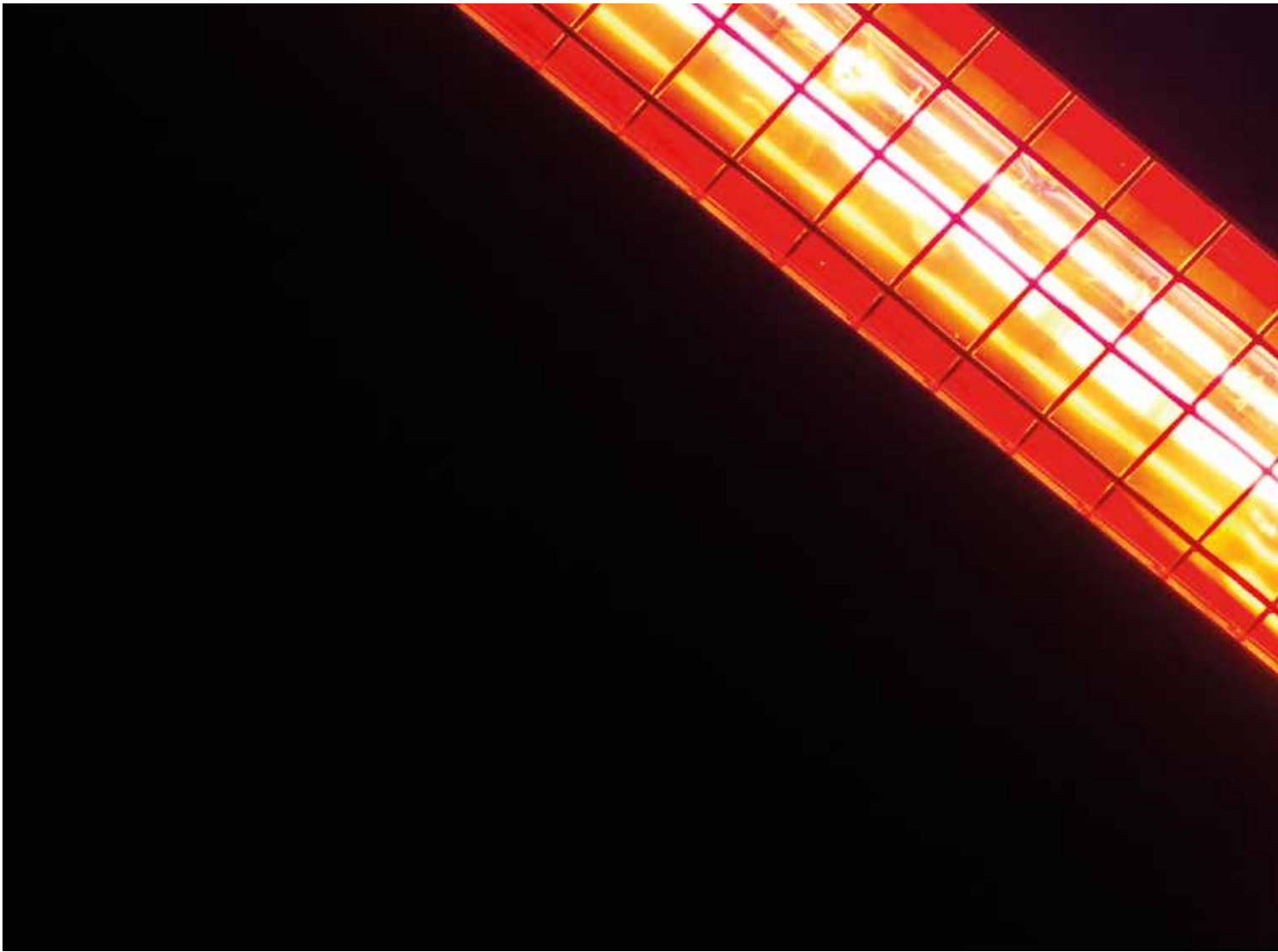

Drying Technology

**Infrared dryers and UV dryers for
efficient paint curing**

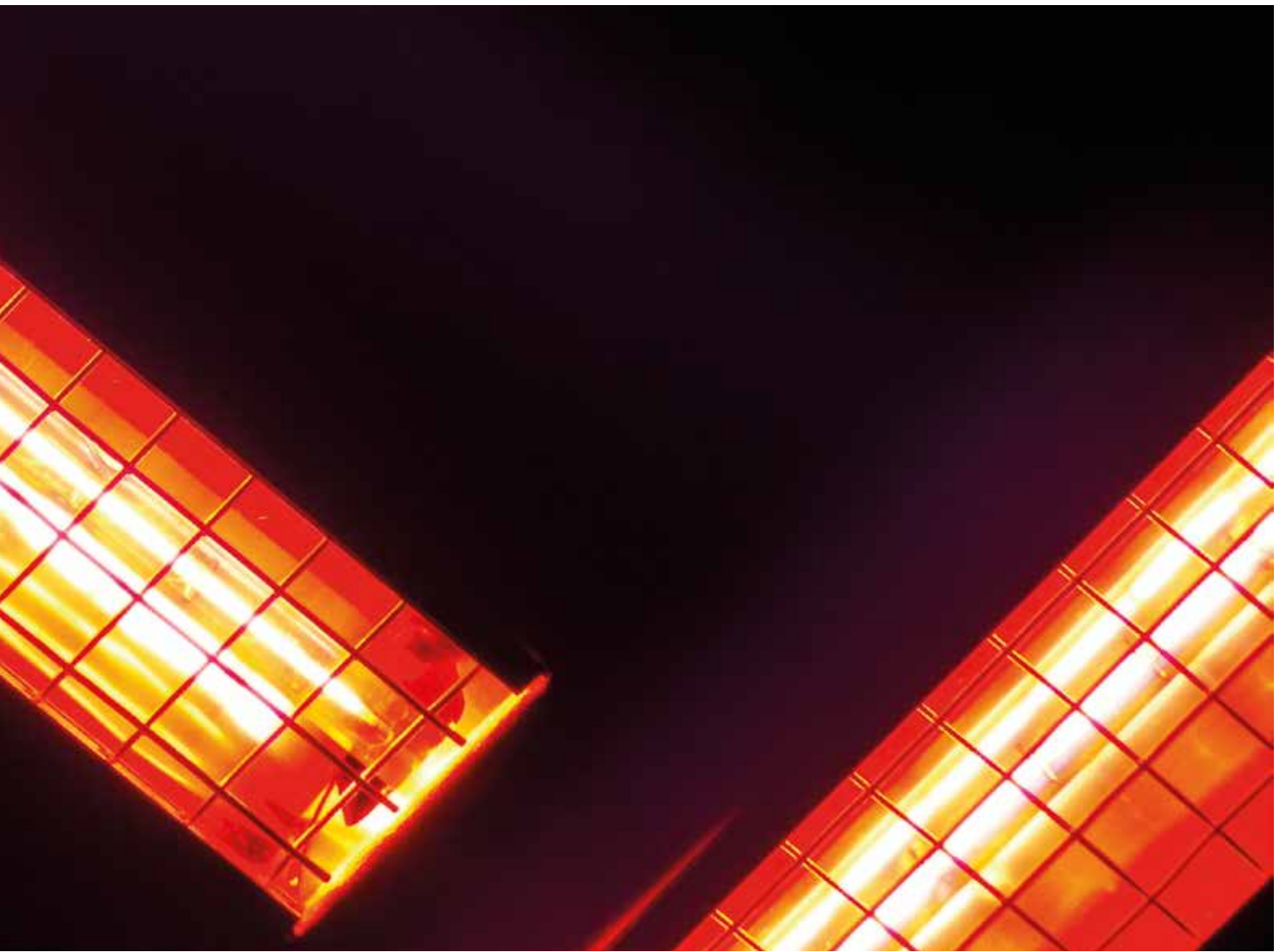

Infrared dryer

UV dryer

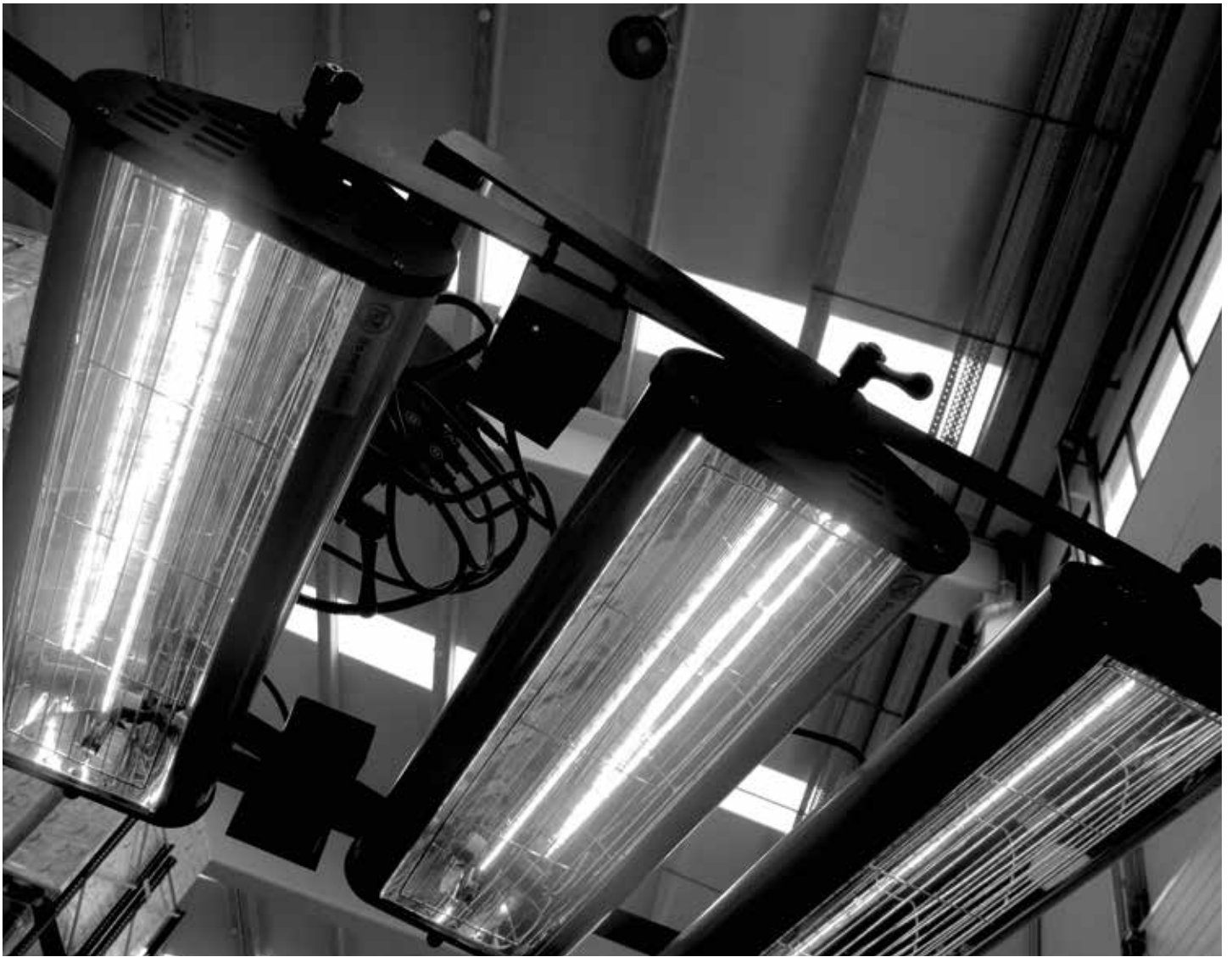

Infrared dryer

IR-B08-Evolution

IR-B02

IR-B03-Evolution

IR-B01-B

IR-B02-Evolution

IR-B01

IR-B06 / IR-B06-T

ST-01

IR-B03 / IR-B03-T

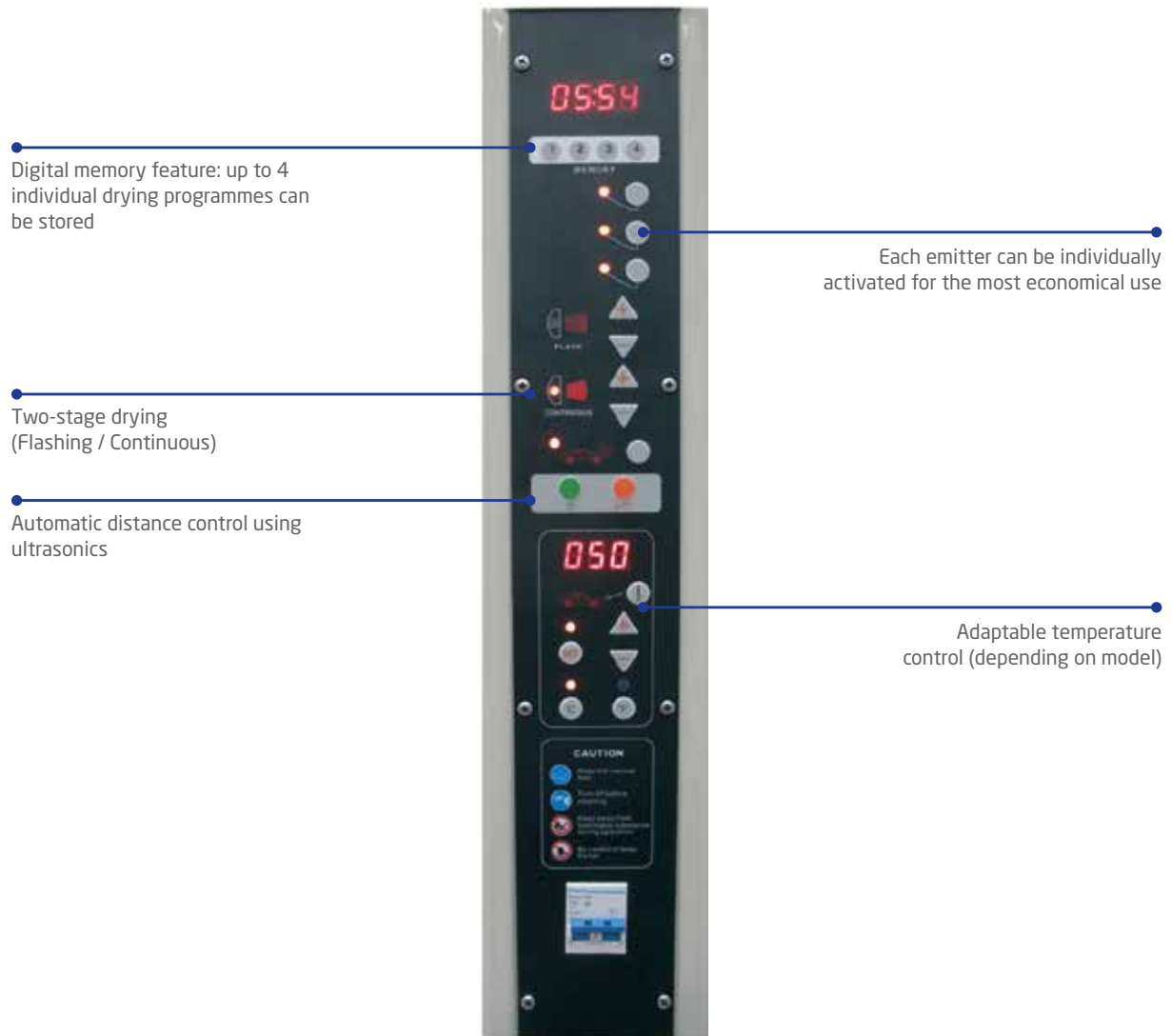

ultrasonic distance sensor | short-wave infrared | low frame height | temperature sensor | 10 m power cable - high flexibility





IR-B08- Evolution

Short wave infrared dryer with 8 gold metallized emitters and reflectors

Art-No. 10000988



Specifications

- 8 gold metallized emitters and reflectors
- shortest drying times
- energy saving 400 V, 12.000 Watt
- **including removable Frame Adaptors 360°** - easier to move
- **vertical height adjustable from 160mm to 2.650mm**
- very low frame height - only 10 cm (without the Frame Adaptor 360°)
- 10 m power cable - high flexibility
- spot-repair feature - with only one emitter switched on
- automatic distance control using ultrasonics
- adaptable temperature control
- two-stage drying (Flashing / Continuous)
- ergonomic maneuvering handles
- digital memory feature: up to 4 individual drying programmes can be stored
- drying area: approx. 2000 x 1400 mm
- digital progress indicator: excludes insufficient drying after interruption
- **option:** Protection covers

Dimensions

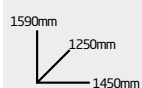

incl. Frame Adaptors 360°

Vertical height adjustable





IR-B03- Evolution

Short wave infrared dryer with 3 gold metallized emitters and reflectors

Art-No. 10000987



Specifications

- 3 gold metallized emitters and reflectors
- shortest drying times
- energy saving 230 V, 3.000 Watt
- **including removable Frame Adaptors 360°** - easier to move
- **vertical height adjustable from 160mm to 2.650mm**
- very low frame height - only 10 cm (without the Frame Adaptor 360°)
- 10 m power cable - high flexibility
- spot-repair feature - with only one emitter switched on
- automatic distance control using ultrasonics
- adaptable temperature control
- two-stage drying (Flashing / Continuous)
- ergonomic maneuvering handles
- digital memory feature: up to 4 individual drying programmes can be stored
- drying area: approx. 1000 x 1100 mm
- digital progress indicator: excludes insufficient drying after interruption
- **option:** Protection cover

Dimensions

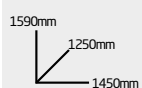

Vertical height adjustable



incl. Frame Adaptors 360°



IR-B02- Evolution

Short wave infrared dryer with 3 gold metallized emitters and reflectors

Art-No. 10001111



Specifications

- 3 gold metallized emitters and reflectors
- shortest drying times
- energy saving 230 V, 3.000 Watt
- 10 m power cable - high flexibility
- spot-repair feature - with only one emitter switched on
- automatic distance control using ultrasonics
- two-stage drying (Flashlight / Continuous)
- drying area: approx. 1000 x 1100 mm
- **option:**
 - Protection cover

Dimensions





IR-B06 / IR-B06-T

Short wave infrared dryer

Art-No. 10000498 / 10000499



Specifications

- Shortest drying times
- energy saving 400 V, 6.120 Watt
- very low frame height - only 10 cm
- 10 m power cable - high flexibility
- each emitter individually activatable
- automatic distance control using ultrasonics
- distance control display
- two-stage drying (Flashing / Continuous)
- easy moving due to ergonomic maneuvering handles
- digital memory function: up to 4 individual drying programmes can be stored
- drying area: approx. 1000 x 1500 mm
- digital progress indicator: excludes insufficient drying after interruption
- **options:** Frame Adaptors 360°, Protection covers

Dimensions

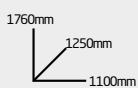

Vertical height adjustable

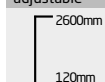

 Infrared dryer **IR-B06-T** includes additional temperature control



IR-B03 / IR-B03-T

Short wave infrared dryer

Art-No. 10000483 / 10000497



Specifications

- Shortest drying times
- energy saving 230 V, 3.060 Watt
- very low frame height - only 10 cm
- 10 m power cable - high flexibility
- each emitter individually activatable
- automatic distance control using ultrasonic
- distance control display
- two-stage drying (Flashing / Continuous)
- easy moving due to ergonomic maneuvering handles
- digital memory function: up to 4 individual drying programmes can be stored
- drying area: approx. 1000 x 800 mm
- digital progress indicator: excludes insufficient drying after interruption
- **options:** Frame Adaptors 360°, protection cover



▲ Frame Adaptors 360°

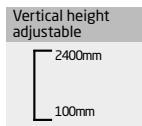
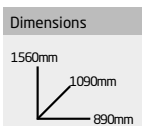

▲ Infrared dryer **IR-B03-T** includes additional temperature control



IR-B02

Short wave infrared dryer

Art-No. 10000496



Specifications

- Shortest drying times
- energy saving 230 V, 2.040 Watt
- 10 m power cable - high flexibility
- each emitter individually activatable
- automatic distance control using ultrasonic
- distance control display
- two-stage drying (Flashing / Continuous)
- easy moving due to rollers
- drying area: ca. 600 x 800 mm
- **option:** Protection cover

Dimensions





IR-B01-B

Short wave infrared dryer

Art-No. 10000495



Specifications

- Shortest drying times
- energy saving 230 V, 1.020 Watt
- two-stage drying (Flashing / Continuous)
- easy moving due to rollers
- drying area: approx. 600 x 400 mm
- **option:** protection cover



Dimensions





IR-B01

Short wave infrared dryer

Art-No. 10000484



Specifications

- Shortest drying times
- energy saving 230 V, 500 Watt
- two-stage drying (Flashlight /Continuous)
- easy moving due to rollers
- detachable emitter panel
- drying area: ca. 400 x 300 mm
- **option:** protection cover



Dimensions





ST-01

Paint sample dryer

Art-No. 10000485



Specifications

- For wall installation or static use on a firm surface
- rapid water based paint sample drying by infrared and compressed air
- **timer for infrared and compressed air**
- infrared temperature control from 35 - 90 °C
- adjustable compressed airflow rate
- infrared and compressed air are combinable functions

Dimensions

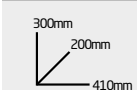



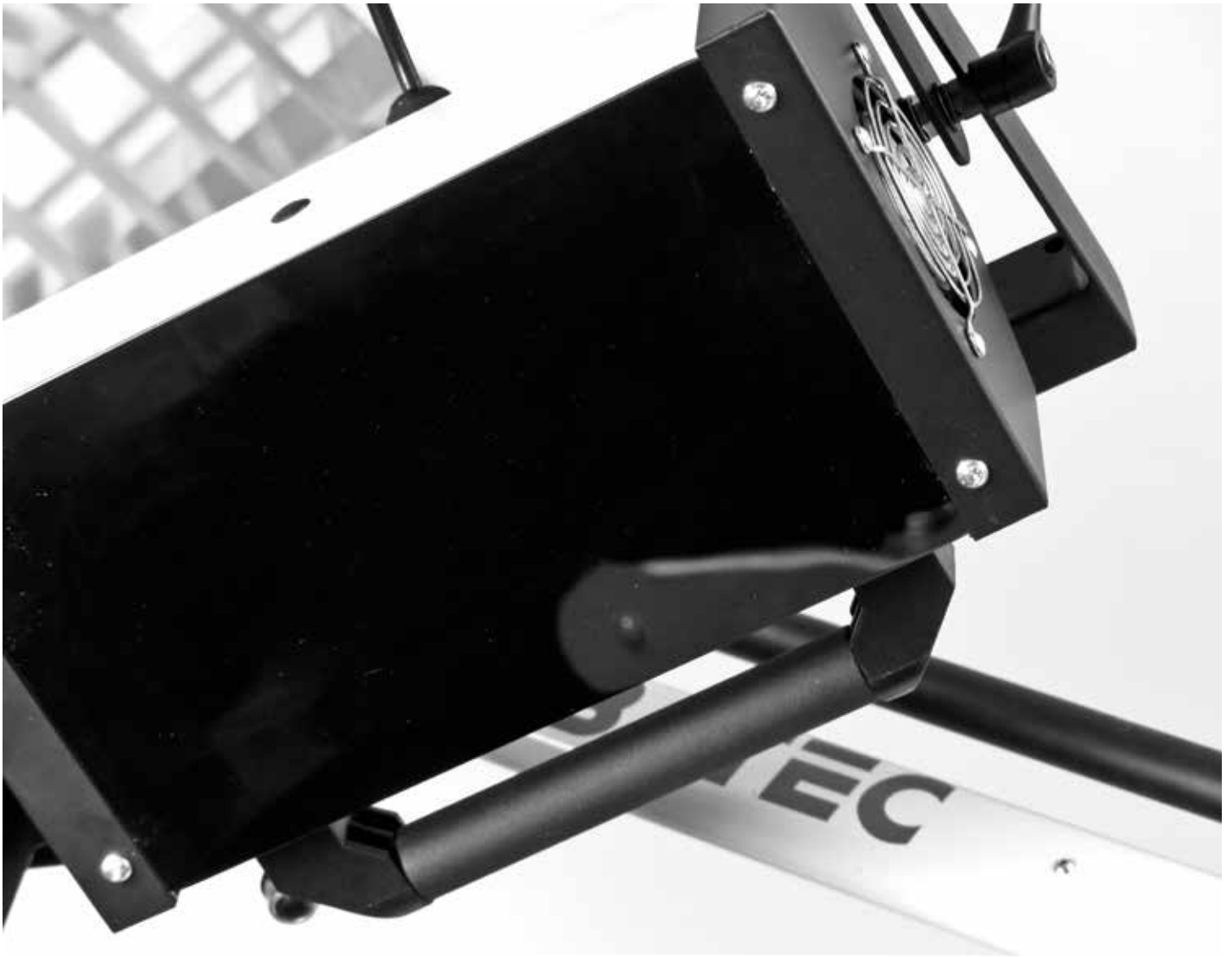

UV dryer

UV-01

UV-02-L

UV-02

UV-04-L

**UV-B/-C filter glass**

All B-TEC UV dryers feature an innovative and efficient UV-B/-C filter glass which filters harmful UV radiation. Only the relevant nonblinding UV-A waves can pass through - blinding is eliminated.

UV-A radiation | very low frame height - only 10 cm | 10 m power cable - high flexibility





UV-01

Ultraviolet dryer

Art-No. 10000771



Specifications

- Rapid UV paint drying
- vertical height adjustment from 200 - 2000 mm
- digital timer
- digital memory function: up to 4 individual drying programmes can be stored
- energy saving 230 V
- power: 400 Watt
- drying area: 400 x 600 mm

Best possible B-TEC-Safety:

Dryer has an effective and tinted UV-B-/C-filter glass.

Harmful UV radiation and blinding is eliminated.

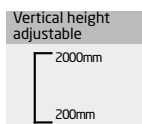
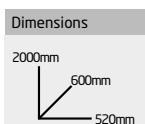



UV-02

Ultraviolet dryer

Art-No. 10000768



Specifications

- Rapid UV paint drying
- vertical height adjustment from 200 - 2000 mm
- digital timer
- digital memory function: up to 4 individual drying programmes can be stored
- energy saving 230 V
- power: 2x 400 Watt
- drying area: 800 x 600 mm

Best possible B-TEC-Safety:

Dryer has an effective and tinted UV-B-/C-filter glass.

Harmful UV radiation and blinding is eliminated.

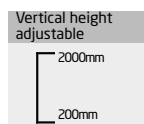
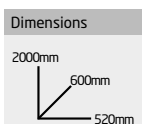



UV-02-L

Ultraviolet dryer

Art-No. 10000769



Specifications

- Rapid UV paint drying
- vertical height adjustment from 400 - 2400 mm
- digital timer
- digital memory function: up to 4 individual drying programmes can be saved
- energy saving 230 V
- power: 2x 400 Watt
- drying area: 400 x 1200 mm
- very low frame height - only 10 cm
- **option:** Frame Adaptors 360°

Best possible B-TEC-Safety:

Dryer has an effective and tinted UV-B-/C-filter glass.

Harmful UV radiation and blinding is eliminated.

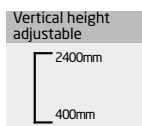
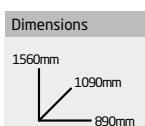



UV-04-L

Ultraviolet dryer

Art-No. 10000770



Specifications

- Rapid UV paint drying
- vertical height adjustment from 400 - 2400 mm
- digital timer
- digital memory function: up to 4 individual drying programmes can be stored
- energy saving 230 V
- power: 2x 400 Watt
- drying area: 800 x 1200 mm
- very low frame height - only 10 cm
- **option:** Frame Adaptors 360°

Best possible B-TEC-Safety:

Dryer has an effective and tinted UV-B-/C-filter glass.
Harmful UV radiation and blinding is eliminated.



▲ Frame Adaptors 360°

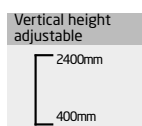
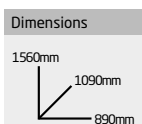



Vehicle Lifts

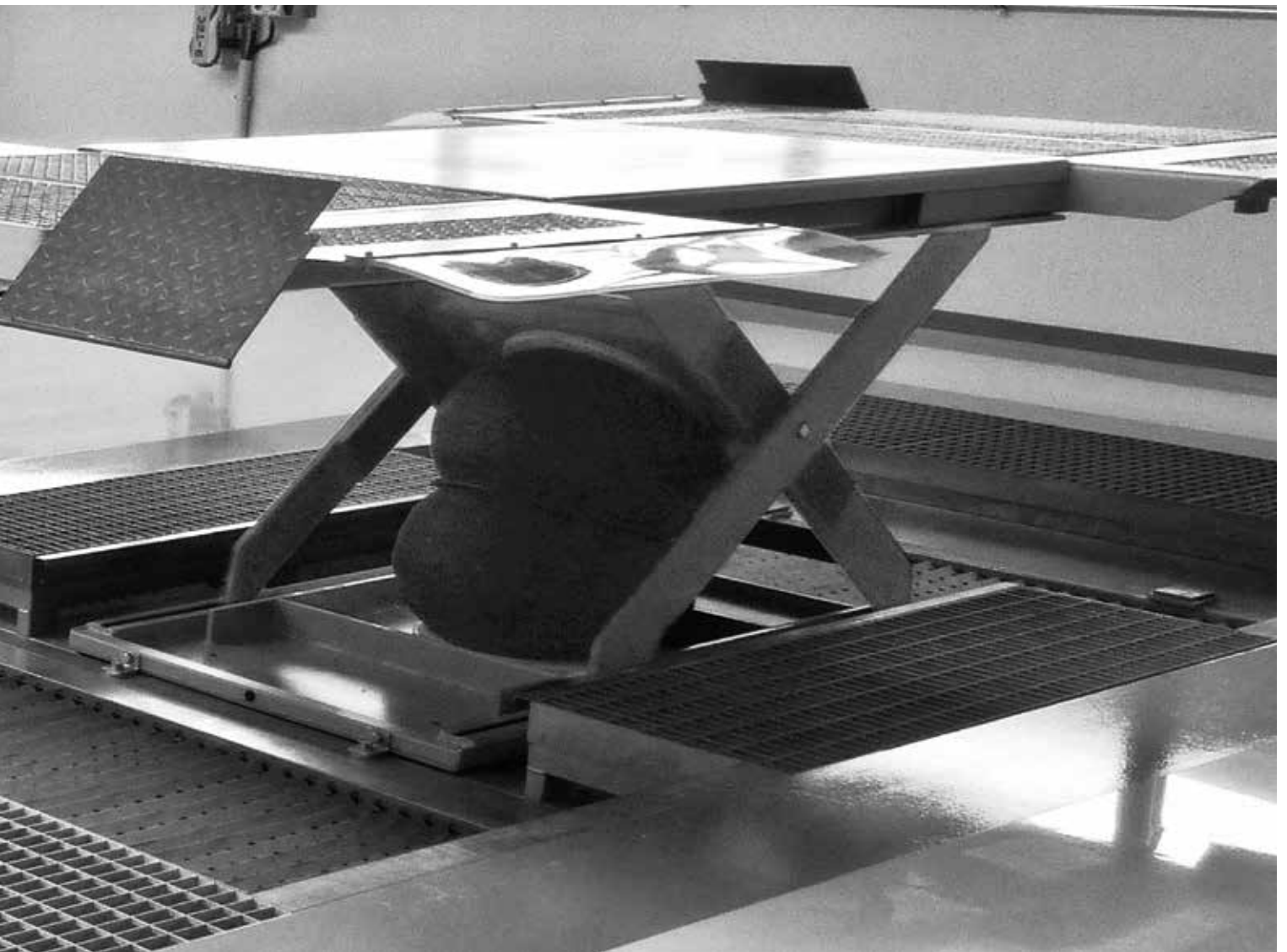

Carry-B / -S / -EB

Carry XL-S / -EB

Carry Twin-S / -EB

Carry Twin XL-S / -EB

Carry Swing

PR-02 / PR-03



Carry-B /-S /-EB

Surface mounted version or in-ground version

Art-No. 10000059 /
10000055 / 10000060



Specifications

- **3.3 tonnes lifting capacity**
- provides a better ergonomic working height and therefore improves the work quality
- enables a working height of circa 1.280 mm
- double safety feature with protected fall-safeguard mounted on the platforms
- air bellows installed below the scissor - hence almost flat upper surface
- high-quality one piece air bellows
- gratings inside the Carry-S and Carry-EB outriggers enable water and snow to drain away
- surface mounted version (**Carry-B/ -S**) or in-ground version (**Carry-EB**)
- weight: 876 kg (**Carry-B**), 883 kg (**Carry-S**), 853 kg (**Carry-EB**)
- **option:** Part or full zinc spraying

Dimensions

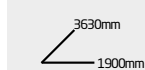

(without ramps)

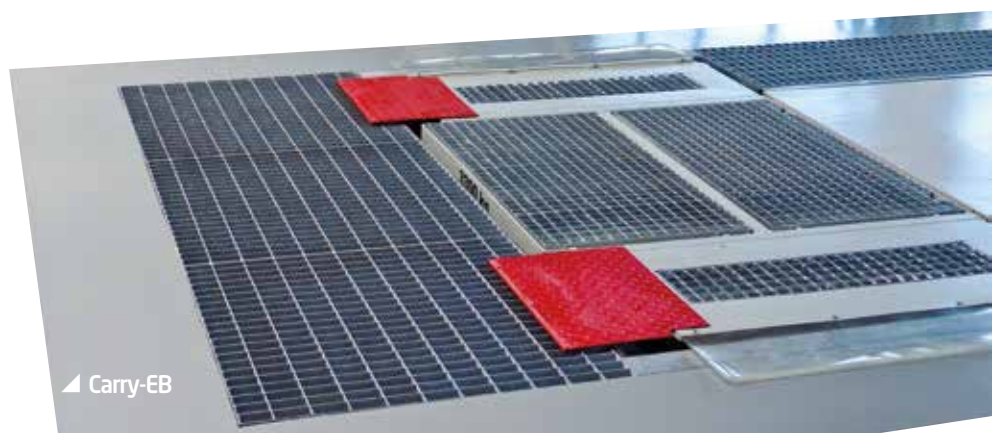

Carry-EB



Carry XL-S / -EB

Surface mounted version or in-ground version

Art-No. 10000051 / 10000052



Specifications

- **3.5 tonnes lifting capacity**
- provides a better ergonomic working height and therefore improves the work quality
- enables a working height of circa 1.280 mm
- double safety feature with protected fall-safeguard mounted on the platforms
- air bellows installed below the scissor - hence almost flat upper surface
- high-quality one piece air bellows
- practical holes inside the outriggers enable water and snow to drain away
- new length and width for small up to long wheelbase vehicles
- surface mounted version (**Carry XL-S**) or in-ground version (**Carry XL-EB**)
- weight: 998 kg (**Carry XL-S**), 953 kg (**Carry XL-EB**)
- **option:** Part or full zinc spraying



Dimensions



(without ramps)



Carry Twin -S / -EB

Lift for lifting on wheels or wheel-free -
surface mounted version or in-ground version

Art-No. 10000065 / 10000066



Specifications

- 3.3 tonnes lifting capacity on wheels,
3.0 tonnes lifting capacity when lifting wheel-free
- Telescopic Support Arms enable wheel-free lifting of very long vehicles such as BMW 7, VW T6, Mercedes Vito or very short vehicles like Fiat Punto
- gratings inside the outriggers enable water and snow to drain away
- 360° rotatable Telescopic Support Arms
- optimal wheel free lifting of lowered cars using jacking points
- double safety feature with protected fall-safeguard mounted on the platforms
- surface mounted version (**Carry Twin-S**) or in-ground version (**Carry Twin-EB**)
- enables a working height of circa 1.280 mm
- perfect for paint and bodywork repairs
- weight: 982 kg (**Carry Twin-S**), 930 kg (**Carry Twin-EB**)
- **option:** Part or full zinc spraying



▲ Carry Twin-S



▲ Carry Twin-S

Dimensions

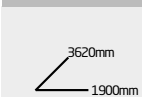

(without ramps)



Carry Twin XL-S / -EB

Lift for lifting on wheels or wheel-free -
surface mounted version or in-ground version

Art-No. 10000062 / 10000061



Specifications

- 3.5 tonnes lifting capacity on wheels,
3.0 tonnes lifting capacity when lifting wheel-free
- Telescopic Support Arms enable wheel-free lifting of very long vehicles such as BMW 7, VW T6, Mercedes Vito or very short vehicles like Fiat Punto
- provides a better ergonomic working height and therefore improves the work quality
- enables a working height of circa 1.280 mm
- double safety feature with protected fall-safeguard mounted on the platforms
- air bellows installed below the scissor - hence almost flat upper surface
- practical holes inside the outriggers enable water and snow to drain away
- surface mounted version (**Carry Twin XL-S**) or in-ground version (**Carry Twin XL-EB**)
- new length and wideness for small up to long wheelbase vehicles
- weight: 1.149 kg (**Carry Twin XL-S**), 1.058 kg (**Carry Twin XL-EB**)
- **option:** Part or full zinc spraying

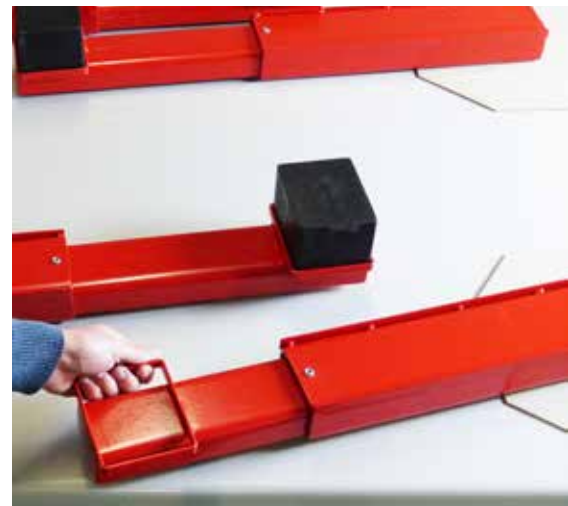

Dimensions

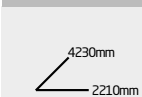

(without ramps)



Carry Swing

Mobile car tilting lift with up to
3.0 tonnes lifting capacity

Art-No. 10000050



Specifications

The mobile, space saving and tilting car lift with up to 3.0 tonnes capacity

- lifts and tilts up to 2.0 tons
- lifts up to 3.0 tons without tilting feature
- adjustable lift pads, each (W x L) 180 x 800 mm
- push-in safety pin can fix unit at various heights
- indoor and outdoor use possible (subject to a safe surface)
- perfect for paint, body or wheel works
- comfortable working height - no bending or lying on cold floors

Dimensions

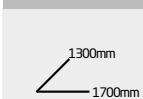

(without ramps)

vertical height adjustable

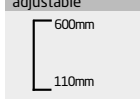



PR-02 / PR-03

Pneumatischer Radfreiheber

Art-No. 10000058 / 10000049



Specifications

- Universal use on a lift, beside a pit or on any solid floor
- lowered height only 153 mm (PR-02) / 190 mm (PR-03)
- raised height 343 mm (PR-02) / 447 mm (PR-03)
- lifting capacity: 2000 kg
- weight: 11 kg (PR-02) / 18 kg (PR-03)
- secure stand
- flexible use
- smooth lifting





Solvent Recyclers

Convincing reasons to choose B-TEC solvent recyclers:

- Reduces solvent consumption! On average, a company consumes more than 50 liters of solvent a day and generates approximately **12000** liters per year.
- Natural resources are limited! Every source of raw material runs dry over time. **Solvent recycling** helps saving limited natural resources.
- Stop **environmental damages**! Contaminated solvent due to cleaning processes is recyclable. Nevertheless, companies spend a lot of money on the disposal of used solvents - or even dispose it illegally. Everybody should be aware of the impact on humans, animals and the environment by using dangerous and toxic products.
- Save costs! The saving potential due to **solvent recycling** is around **80%** compared to the purchasing of new solvent.
- A profitable investment! The payback period for solvent recyclers is often no longer than **9 months** and only grants advantages - for the company and the environment.
- Fit for the future! The environment and our following generations will thank you for this investment.



SD-Line

Solvent Recyclers

Art-No. 10000944 -
10000950



Specifications

Distiller for recycling of contaminated solvent and water

- condenser, tank and boiler made of stainless steel - suitable for distillation of cleaners with chloride components
- complies with ATEX directive 94/9/EG and can be installed in Zone 1 (ATEX Ex II 2G)
- efficient fluid recovery due to large evaporation area
- ergonomic construction
- can be tilted for easy tank discharging
- safety features to prevent overheating of electrical element, oil and distillate
- plug & play
- available in the following capacities:
15 L, 20 L, 30 L, 50 L, 70 L, 120 L, 200 L - further dimensions on request
- average recovery cycle time (based on the 15 - 50 L versions): ~ 4 hrs

Technical specifications available on
<https://www.btecsystems.de/technical-data>
Warranty: One year starting from delivery date



Working Tables



Painty-01

AS-600 / AS-B

Painty-02 / Painty-03

AS-1200 / AS-1200-E

Painty-04

AS-E



Painty-01

Mixing and preparation table

Art-No. 10000015



Specifications

- Keeps your workplace organized
- robust construction
- includes drain
- large work place made of stainless steel and aluminium

Included with the Painty-01:

- 4x spray gun holder
- 1x paper roll holder
- strong magnetic bar

Dimensions

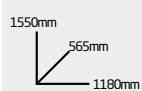



▲ Painty-02

▲ Painty-02 / Painty-03

Painty-02 - Mixing and preparation table with exhaust air system

Painty-03 - Mixing and preparation table with connection for on-site exhaust air system

Art-No. 10000016 / 10000017



Specifications

- Made of stainless steel and aluminium
- **adjustable, pneumatic exhaust air system (Venturi, only Painty-02)**
- includes drain with grating
- edge protection
- two stable storage shelves made of stainless steel

Included with the Painty-02/03:

- 4x spray gun holder
- 1x paper roll holder
- 1x rubbish bag holder
- 1x exhaust air tube

Painty-03 (not pictured) 1800 mm wide including 150 mm exhaust air connection for existing local exhaust air system.

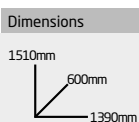



Painty-04

Mixing and preparation table with base cabinet and exhaust air system

Art-No. 10000008



Specifications

Painty-04 with exhaust air system which provides extraction from the table work area and the base cabinet

- made of stainless steel
- pneumatic exhaust air system
- includes drain with grating
- edge protection
- lockable base cabinet with two stable storage shelves made of stainless steel



Dimensions

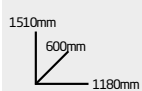



▲ AS-600

AS-600 AS-B

Modular working table design

Art-No. 10000009 / 10000012



Specifications

Working table AS-600

- works perfectly as scale table in individual heights

Working table AS-B

- with high quality sink
- includes overflow device (without water tap)



▲ AS-B

Dimensions AS-600



Dimensions AS-B

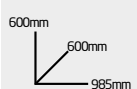



▲ AS-1200

▲ AS-1200

▲ AS-1200-E

Modular working table design

Art-No. 10000010

Art-No. 10001023



Specifications

Working table AS-1200

- including drain with grating (like Painty-02)
- works perfectly as scale table in individual heights

AS-1200-E

- Corner working table



▲ AS-1200-E

AS-600-R



AS-B

Dimensions AS-1200



Dimensions AS-1200-E

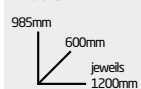

**AS-E**

Corner shelf

Art-No. 10000011

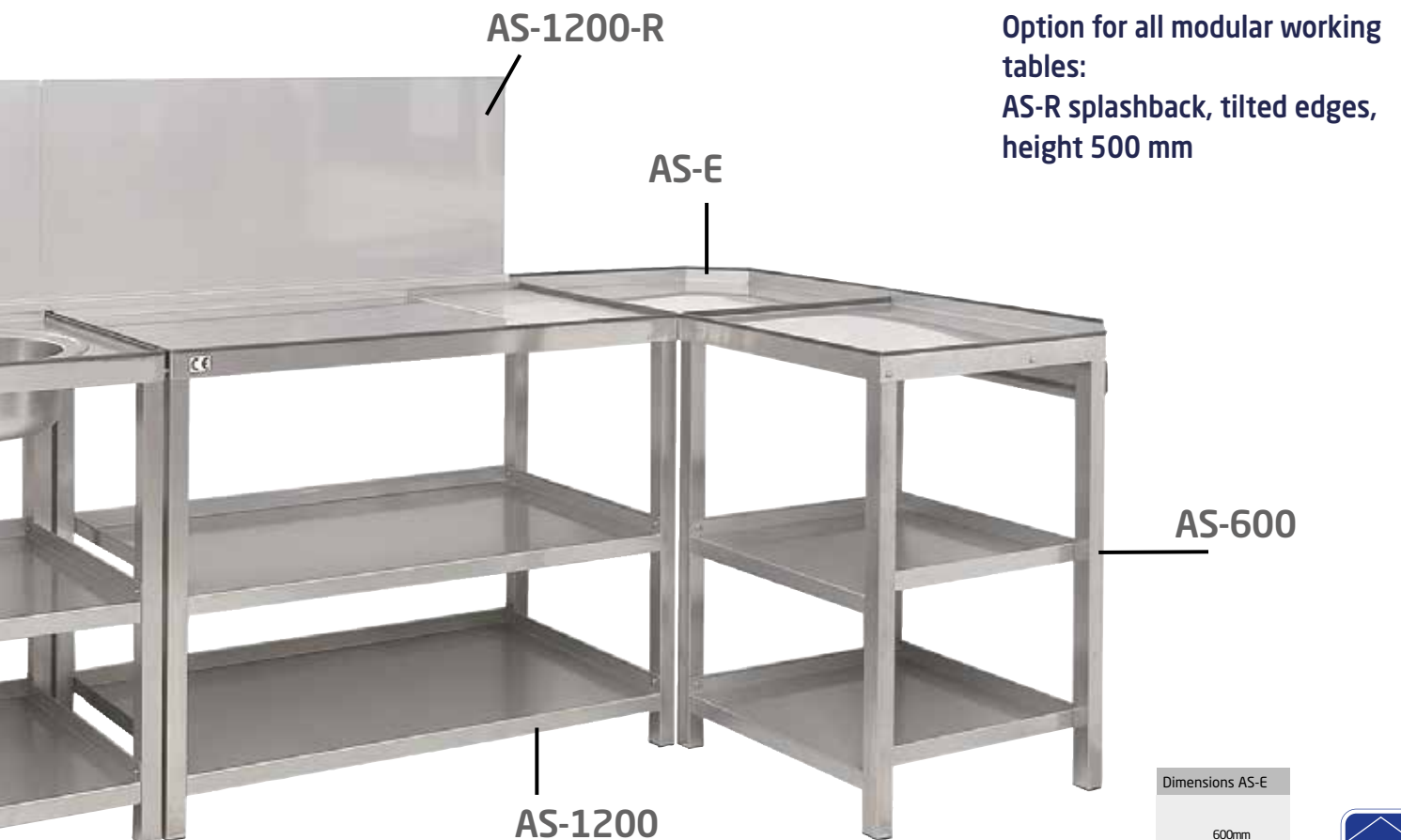

Dimensions AS-E

600mm
600mm



Paint Equipment



**Water based paint
cleaning fluid**

Storage systems

Other equipment



Water based paint cleaning fluid

H₂O-Cleaner-RK

H₂O-Cleaner-RTU

H₂O-Cleaner-RTM



H₂O Cleaner -RK

Water based paint cleaner concentrate for automatic
and manual cleaning

Art-No. 10000633



Specifications

- Cleaner shipped as concentrate: 10 L concentrate + 20 L water = **30 L B-TEC-H₂O-Cleaner** for up to 800-1000 spray gun cleaning cycles
- first water based paint cleaning fluid for automatic spray gun washers
- for **automatic** and manual cleaning
- cleans dried and fresh water based paints from spray guns and tools
- biodegradable
- does not affect the spray gun bodies
- not flammable
- fresh and mild odour (like window cleaning fluid)
- for long-term use - additionally, the fluid can be coagulated and used multiple times
- extends life of all spray gun functions
- only 14 % VOC-value in 30 L ready mixed H₂O-Cleaner

Safety data sheets available on
<https://www.btecsystems.de/downloads-english>



H₂O Cleaner -RTM

Water based paint cleaning fluid
"ready to mix" for manual cleaning

Art-No. 10000634



Specifications

- Water based paint cleaner "ready to mix" for manual cleaning of fresh water based paints in manual gun washers and open containers
- shipped in 30 L canisters - ready to use after filling up with drinking water
- **ready mixed no declaration necessary**
- only 14 % VOC-value in 30 L ready mixed H₂O-Cleaner no hazardous material / no declaration necessary

Safety data sheets available on
<https://www.btecsystems.de/downloads-english>



H₂O Cleaner -RTU

Water based paint cleaning fluid "ready to use"

Art-No. 10000635



Specifications

- **Already mixed water based paint cleaning fluid „ready to use“**
- for in between cleaning stations and rinse bottles
- shipped in 5 L canisters
- **no declaration necessary**

Safety data sheets available on
<https://www.btecsystems.de/downloads-english>



Storage systems

Jumbo-01

MA-01

Jumbo-02

EA 500 / 700

Depot



Jumbo-01

Mobile storage system

Art-No. 1000005

Specifications

- Space-saving and mobile storage system for up to 10 bonnets or 20 bumpers
- foam covered brackets
- high stability
- two lockable castors/rollers

Dimensions

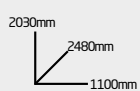



Jumbo-02

Wall mounted storage system

Art-No. 1000001

Specifications

- Wall mounted
- space-saving storage system for up to 5 bonnets or 10 bumpers
- foam covered brackets
- high stability

Dimensions

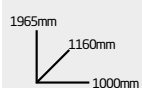



Depot

Mobile storage system

Art-No. 1000003

Specifications

- Safe storage for large parts
- neat storage compartments and shelves
- high mobility
- easiest car allocation
- 4 telescopic brackets
- impact protected racks
- robust construction
- excellent cost-benefit payback

Dimensions

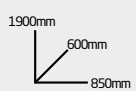

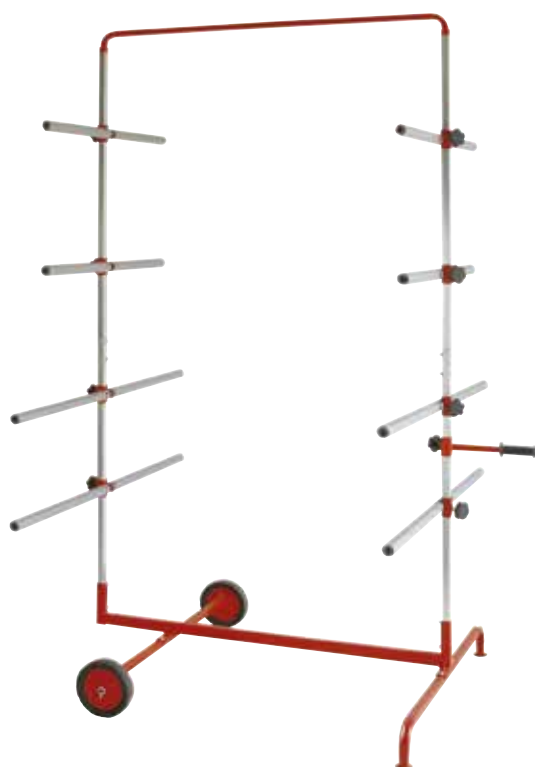

MA-01

Mobile storage system

Art-No. 10000006

Specifications

- Space-saving storage system for up to 8 bumpers
- height-adjustable foam covered brackets
- high stability
- height-adjustable handle
- 4 long and 4 short brackets

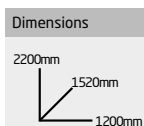



EA 500 / 700

Corner shelf for spray booths

Art-No. 10000002 / 10000000

Specifications

- Robust construction (2 mm aluminium)
- keeps the spray booth organized
- two sizes - **500 mm and 700 mm side lengths**



Other equipment

Sunny-LED

RST-01

STS-18

Jimmy

RST-05

UST-110

CM-900

Twister

CS-300

Speed-Dryer

MD-02

RST-800

PH-01



Sunny-LED

LED-daylight lamp with adjustable stand

Art-No. 10000713

Specifications

- 100 % silicone free
- energy saving and durable LED-technology without switch-on delay
- much better light conditions on the object / full spectrum light
- perfect for color matching
- vertically and horizontally adjustable
- swiveling lamp field
- moveable stand with double castors/rollers to roll over gratings easily
- 10 m power cable
- 6 x 16 Watts, 230 V

Dimensions

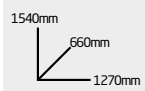

(with vertical lamp field)



Jimmy

The polishing butler

Art-No. 10000719

Specifications

Significant material savings due to upside down position of bottles - shaking of bottles not necessary!

- huge time saving, all polishing equipment in one place
- dust-free storage of cloths and sponges
- space-saving system
- easily moveable due to high quality castors/rollers
- always a clean work place
- mobile or stationary
- robust and durable - made of galvanized steel
- including holder for a polishing machine and a rubbish bag



UST-110

Universal paint table

Art-No. 10000981

Specifications

- 14 adaptors for (simultaneous) fixing of e.g. mirrors, bumpers, wings and headlights
- storage capacity for not used adaptors directly at the table
- mobile due to 4 swivel castors/rollers, 2 of them with brakes - stable on gratings
- table top 360° rotatable
- table top completely made of stainless steel
- robust design

table top dimensions



Vertical height adjustable



Twister

Mobile rotary paint table

Art-No. 10000707

Specifications

- Perfect for small parts
- 4 adjustable part brackets - height 150 mm with PVC protection cap
- 4x 100 mm double castors/rollers, two of them with lock - stable on grid floors
- height adjustable from 870 mm to 1240 mm
- table top 360° rotatable

table top dimensions



Vertical height adjustable



Speed-Dryer

Mobile air blow system

Art-No. 10000738

Specifications

- Can be adjusted to any angle in order to provide optimised air flow concentration
- stepless adjustment in height and width
- including extension for roof area of minivans
- mobile
- large, adjustable feet to be used on gratings
- air blow gun detachable - more flexibility
- filters fitted inside the air blow guns
- usual high B-TEC quality

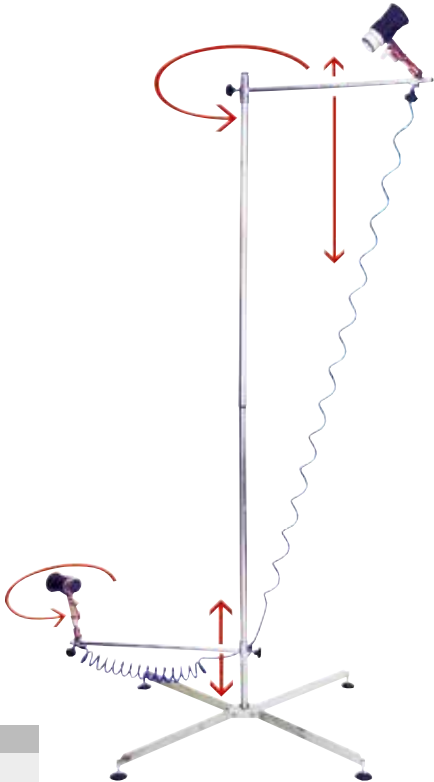

Dimensions

2250mm
1250mm

RST-800

Waste paint collecting station for solvent and water based paints

Art-No. 10001148

Specifications

- Including exhaust air system
- including moveable overflow bund
- also for multiple paint tins up to 5 liters
- shipped including 2 pails and bags



Dimensions

1480mm
655mm
900mm





RST-01

Collecting container for waste paint

Art-No. 10000739

Specifications

- Also for paint tins up to 5 liters
- including exhaust air system
- shipped including pail and bag



RST-05

Blow-out station

Art-No. 10000678

Specifications

- Blow-out station for remaining paint in tube and spray gun before recirculating cleaning liquid is used to clean the inside of tube and spray gun
- **no overspray while blowing out**
- **items delivered:**
Empty barrel with changeable lid, including blow out pipe with lid, exhaust air channel and dipstick.



CM-900

Coagulation powder

Art-No. 10000710

Specifications

- For the coagulation of **B-TEC H₂O-Cleaner-RK**
- **to be used only after complete contamination of the H₂O-Cleaners!**



CS-300

Coagulation kit

Art-No. 10000725

Specifications

... the professional coagulation kit.



MD-02

Space-saving paint stand to be stored on the wall

Art-No. 10000705

Specifications

- **Rotatable axis for wall storage**
- robust construction
- including extension, 6 hooks and 2 spoiler holders
- stable ring gear locking
- high stability
- space-saving
- **option:** wall bracket for up to 3 MD-02



▲ space-saving wall storage



▲ Rotatable axis



PH-01

Paper roll holder

Art-No. 10000687

Specifications

- Wall-mounted version and table version
- robust and durable - made of stainless steel
- to be used with paper rolls up to 390 mm in width



STS-18

Mobile solvent transfer station

Art-No. 10000722

Specifications

Mobile pump and transfer station for solvents or water based cleaners

- for fresh and used liquids
- cannot be left running due to push button activation
- drip tank with ball valve for drainage
- adjustable flow rate
- max. flow rate: 18 liter/min.
- perfect in combination with the B-TEC SD-Line solvent recyclers

CE

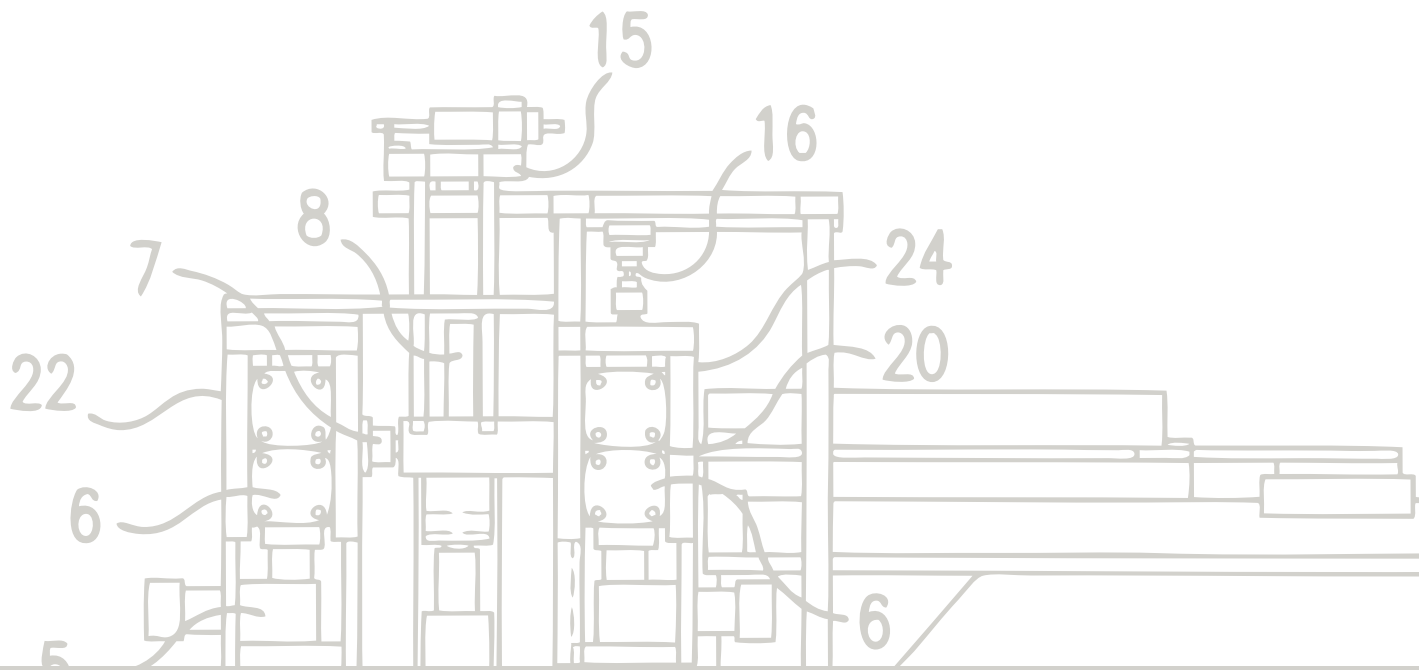

Key machine features that add to the quality and user benefits



With the Kalrez diaphragm our pump is resistant against 1800 different chemicals. Made of corrosion-resistant material, it withstands toughest working conditions in the long term - without a maintenance requirement.



Can be used with B-TEC-H2O-Cleaners



The ergonomical design with comfortable front access enables optimal viewing conditions on all features of the washer without glass plates or bezels which prevent good visibility. Ergonomic and fast cleaner change due to moveable overflow bunds. No laborious removing of any frames or anything similar necessary.



Bright cleaning chambers due to the utilization of stainless steel.
No utilization of light absorbing plastic



Can be used with solvent.



All features fully adjustable.



Opening of the spray / paint guns by a trigger clamp takes place inside the gun washer after the gun sits perfectly on the cleaning nozzle with connected air. Solvent or paint behind the air cap is prevented. No disassembling of the air cap required - less mechanical damage on the paint / spray gun and significant time savings.

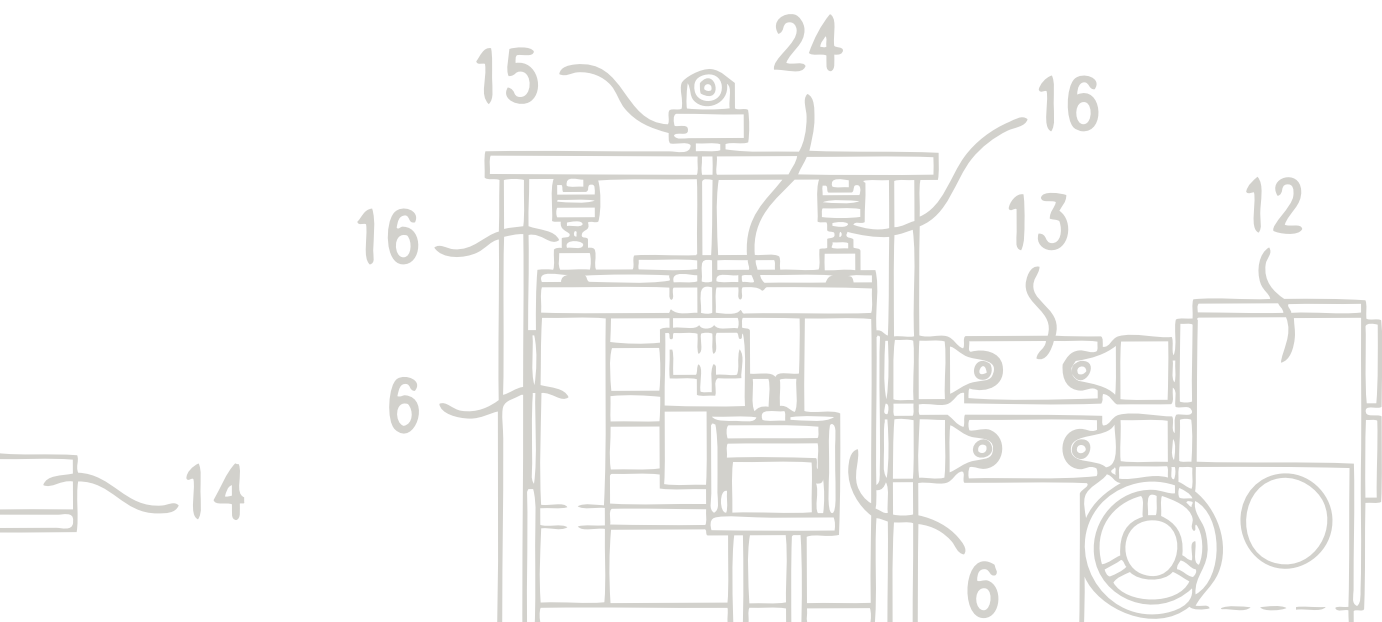

B-TEC products are in use worldwide.
For example at:

B-TEC spray gun washers are recommended by leading paint gun manufacturers all around the world.



Airbus Group

Akzo-Nobel

Audi AG

Axalta

BASF

BMW AG

BOSCH

Carl Zeiss

Daimler Chrysler AG

Danfoss A/S

EDAG Engineering Design AG

EVO-Bus

Fanuc Robotics Europa S.A.

Ford

Hella Innenleuchten Syst. GmbH

Hörmann Tore

KAESER KOMPRESSOREN SE

Lotus

Lufthansa

Magna

Philips

Porsche

PPG

Renault

Rolls-Royce

Seat

Skoda

Toyota

Volkswagen AG

WABCO GmbH

ZF Lemförde AG

and many more...

**made
in
Germany**

All B-TEC spray gun washers are made in Germany and meet different requirements all around the world - innovative, patented technology "made in Germany".

For more information about the B-TEC innovations please visit <https://www.btecsystems.de/innovations>



Scribbles & notes

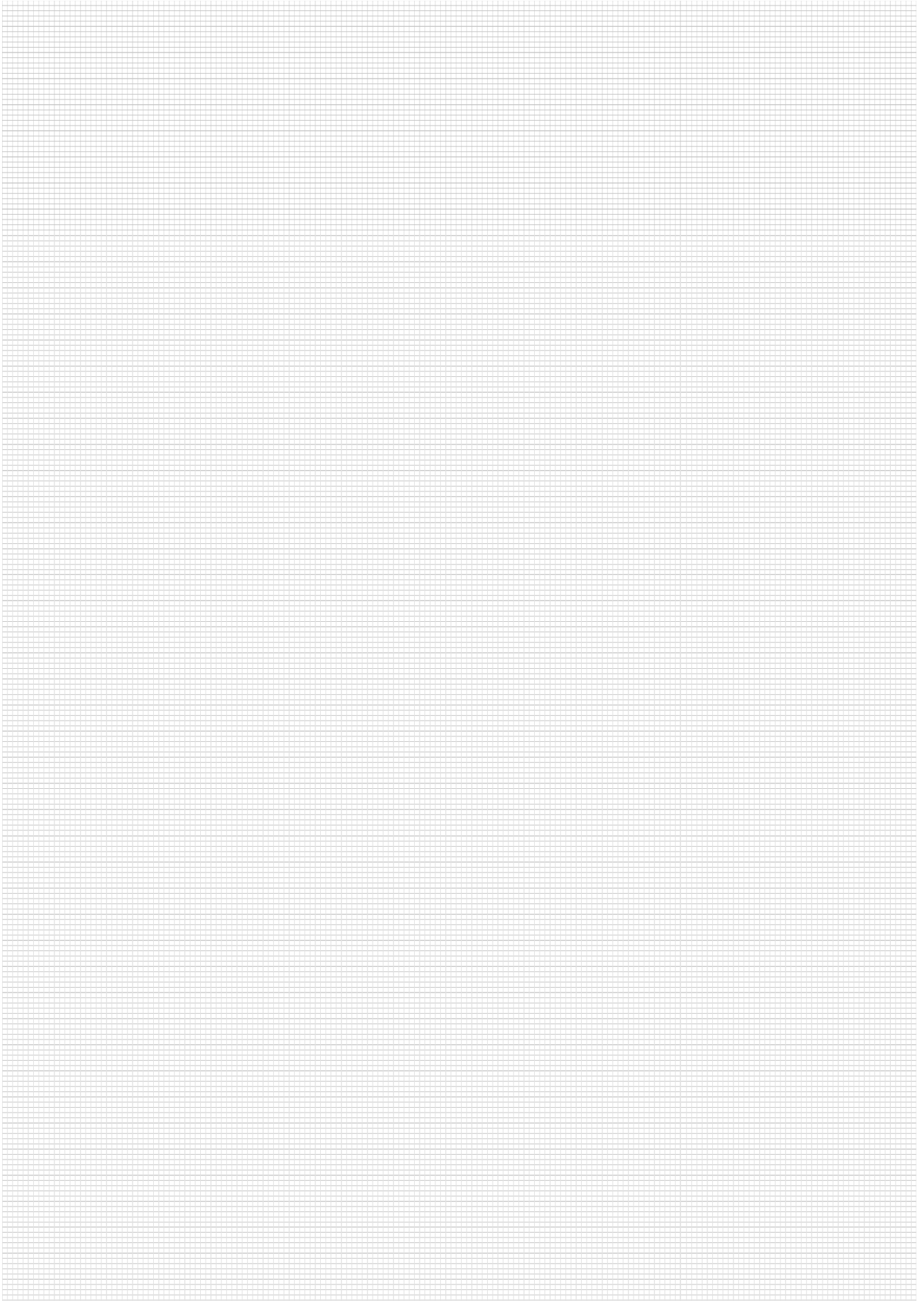

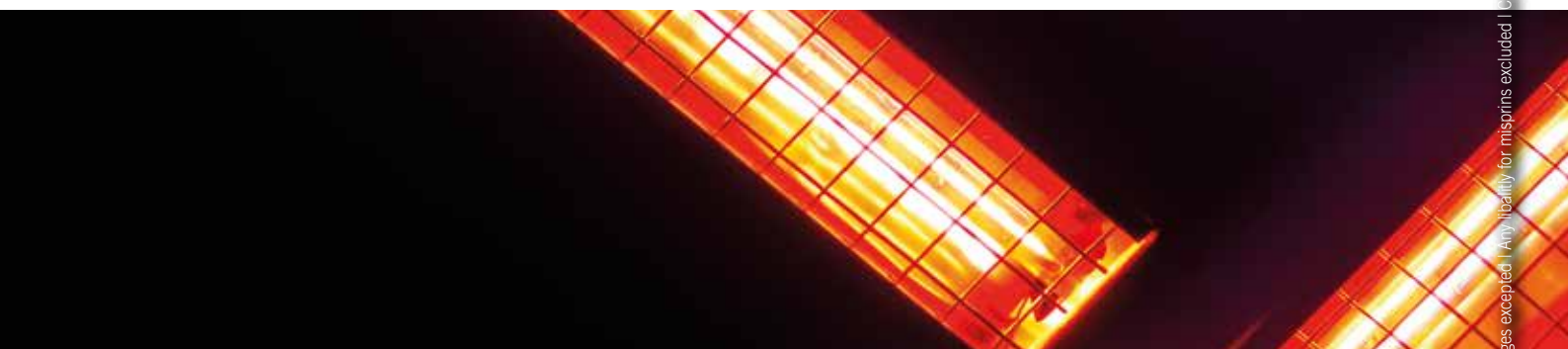

B-TEC® GmbH

Zunftweg 6-8
31303 Burgdorf/Ehlershausen - Germany
fon: +49 50 85 97 100 0
fax: +49 50 85 97 100 30
mail: info@btcesystems.de
www.btcesystems.com