

The Wagner logo features a black triangle above the word "WAGNER" in a bold, black, sans-serif font, all contained within a yellow rectangular background.

WAGNER

Contractor - 2024 -

PRODUCT NAVIGATION



BE UNSTOPPABLE!

INNOVATION SINCE 1947

Perfect surfaces and added value are our passion. Bringing colour, protection and function to surfaces is our mission. We dedicate all of our technical expertise to enhance our products, and support you with a personal level of service. Using

innovative Technologies and highly efficient, reliable and user-friendly solutions, we are constantly setting new standards in surface technology.

WAGNER GROUP WORLDWIDE

- Around 2,000 employees
- 19 operational companies, including 5 production plants
- Around 400 international agencies
- A 1,500 m² Technology Centre in Markdorf and a further 7 throughout the world
- Worldwide service directly on site



Facades, walls, furniture, doors, steel structures, mobile phones, car wheel rims and controls, leather sofas and radiators – there are hardly any objects which cannot be surface finished. Clearly along with function, durability and attractiveness, the surface of an object is its definition. Your customers, as professionals all want to achieve a high level quality finish. WAGNER can help support your business with high quality professional equipment which is both time saving and cost effective.

Different application areas characterise the product range of the contractor sector: **SMALL PROJECTS:** Spraying units for repair and touch-up work. Ideal for all projects in the renovation and new construction sector when using the unit irregular and rare. Good price-performance ratio.

BUILDING TRADE: Units for Painters and Plasterers. Ideal for all interior and exterior applications, for a wide range of surfaces, walls, ceiling radiators and door frames. Powerful screw pumps for heavy aggregated material.

WOOD AND METAL WORK: Spray units for painting a wide range of objects such as stairs, floors, kitchens, furniture and railings with water diluted or solvent based

paints.

CORROSION AND STRUCTURAL PROTECTION: Applying protective coatings with airless technology and electric or petrol-driven piston pumps.





PREPARING: Power tools for the removal of paint and wallpaper.



The range for each stretches from small entry level units through all rounder units right up to specialised plant. Comprehensive accessories guarantee an optimal match to the object in question.

WAGNER develops numerous product innovations in close contact with users, paint manufacturers and scientific institutions. Our 1500 square metre technology centre in Markdorf plays an important role in practical research and relaying knowledge. For example interregional master classes to consoli-date the training for the painting trade have taken place here for years. We provide a comprehensive Service Network and also a large number of specialist advisers to help you in an instant.

PUMP OVERVIEW ACCORDING TO MATERIALS

MATERIALS	Water and solvent-based paints, lacquers, oils, separating agents	Synthetic resin varnishes, PVC lacquers, 2K lacquers	Primers, fillers	Fire protection, rust protection paints	Emulsion and latex paints, adhesives, sealants	Exterior paints, roof coatings, floor coatings, textured paint	Structural water-proofing, bituminous coatings	Filler	Plaster	Injection
FinishControl 3500	🏠	🏠	🏠		🏠					
FinishControl 4000 18V	🏠	🏠	🏠		🏠					
FinishControl 5500	🏠	🏠	🏠		🏠					
FineCoat 9700	🏠	🏠	🏠							
FineCoat 9900 Plus	🏠	🏠	🏠							
SuperFinish 21 Pro HEA	🏠	🏠	🏠	🏠	🏠					
SuperFinish 21 Pro Airless Enamel	🏠	🏠	🏠	🏠	🏠					
SuperFinish 23 Pro HEA	🏠	🏠	🏠	🏠	🏠	🏠				
SuperFinish 23 Plus HEA	🏠	🏠	🏠	🏠	🏠	🏠				
SuperFinish 23 Plus Airless Enamel	🏠	🏠	🏠	🏠	🏠	🏠				
SuperFinish 23 Plus TempSpray	🏠	🏠	🏠	🏠	🏠	🏠				
SuperFinish 23 Plus AirCoat Enamel	🏠	🏠	🏠	🏠	🏠	🏠				
SuperFinish 23 CR	🏠	🏠	🏠	🏠	🏠	🏠				🏠
SuperFinish 33 Pro	🏠	🏠	🏠	🏠	🏠	🏠				
SuperFinish 33 Plus	🏠	🏠	🏠	🏠	🏠	🏠				
PowerPainter 90 Extra	🏠	🏠	🏠	🏠	🏠					
ProSpray 3.20 HEA	🏠	🏠	🏠	🏠	🏠					
ProSpray 3.21 HEA	🏠	🏠	🏠	🏠	🏠					
ProSpray 3.25	🏠	🏠	🏠	🏠	🏠	🏠				
ProSpray 3.31	🏠	🏠	🏠	🏠	🏠	🏠	🏠			
ProSpray 3.39 Emulsion	🏠	🏠	🏠	🏠	🏠	🏠	🏠	🏠		
ProSpray 3.39 Filler	🏠	🏠	🏠	🏠	🏠	🏠	🏠	🏠		
HeavyCoat 750 E/G & E SSP				🏠	🏠	🏠	🏠	🏠		
HeavyCoat 950 E/G & E SSP				🏠	🏠	🏠	🏠	🏠		
HeavyCoat 970 E/G & E/G SSP				🏠	🏠	🏠	🏠	🏠		
PlastCoat HP 30					🏠	🏠	🏠	🏠		
PlastCoat 1030 E								🏠	🏠	

 Small projects up to 50 m²
 Residential 50 m² - 200m²
 Large residential 200 m² - 800m²
 Commercial more than 800m²

 Suitable material
  Suitable material - additional accessories are needed

**NOW EVEN
MORE
COMPREHENSIVE**



XVLP / HVLP



AirCoat



Airless

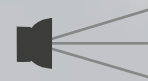

Plaster spraying

MACHINE & MATERIAL PERFECTLY MATCHED

→ Search by material type

→ Search by material manufacturer

→ Search by WAGNER machine and systems

→ For all spraying technologies

NEW

→ WAGNER Spray Approved

NEW



To our SprayGuides:
go.wagner-group.com/sprayguide

WAGNER
GUARANTEE

3+2
EXTRA YEARS

The extensive WAGNER SprayGuide offers you test reports from well-known material manufacturers for use with WAGNER spray machines.

Visit go.wagner-group.com/sprayguide to find out how to set up your machine to match the material you are using, and which paints and lacquers can be sprayed most effectively with WAGNER technology.

Anyone purchasing a WAGNER paint sprayer automatically receives a three-year manufacturer's warranty. But we can do more: If you register online, you can extend this warranty for a further two years, free of charge!

go.wagner-group.com/3plus2



FURTHER TRAINING IN OUR MODERN TRAINING CENTRE

Equipment technology represents the future of professional painting and decorating within the context of normal, efficient, high-quality site work. This is why it is particularly important to us to not only provide you with the technology but also to convey the corresponding know-how. After all, even the very best products only create the best surface when used in combination with specialist professional knowledge.

Whether user, plant manager, material manufacturer or sales partner - the new WAGNER ACADEMY offers every target group high-quality training modules for professional and personal further education.

THE TRAINING CENTRE IN MARKDORF ON LAKE CONSTANCE HAS AT ITS DISPOSAL:

- Three seminar rooms with state-of-the-art presentation and conference technology
- Practical zone with different, mobile demo areas
- Technical centre for service issues
- Painting booth with extraction system

	BASIC CERTIFICATION	ADVANCED CERTIFICATION	EXPERT CERTIFICATION
WAGNER training courses to choose from	<ul style="list-style-type: none"> • Mechanical paint application from paint to plaster 	<ul style="list-style-type: none"> • Paint materials • Interior wall paint • Exterior & building protection material • Fillers & plaster 	<ul style="list-style-type: none"> • HVLP & XVLP technology • SuperFinish technology • ProSpray technology • HeavyCoat technology
Duration	1 day (50 % Theory, 25 % Demo, 25 % Training)	1 day (50 % Theory, 25 % Demo, 25 % Training)	1 day (45 % Theory, 10 % Demo, 45 % Training)
Prior knowledge	none	WAGNER Basic Operator Training (recommendation)	WAGNER Advanced Operator Training (recommendation)



You can find training dates online at go.wagner-group.com/academy-contractor
Registration and further information can also be found on our website.

We come to you!
All training courses can also be held conveniently at your premises.
Please contact us at:
Academy.DF@wagner-group.com or call +49 (0) 7544 505 1602

FOR QUICK ANSWERS

DIGITAL SERVICES

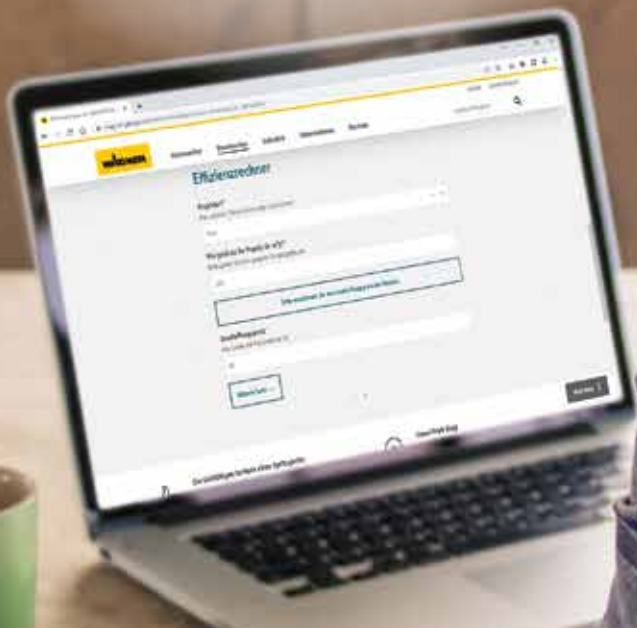

NEWSLETTER "PROFESSIONAL NEWS"

ALWAYS UP TO DATE

The monthly newsletter offers the perfect mix of practical tips, interesting industry insights, useful instructions, exclusive competitions and much more relating to the professional trade. Register now and don't miss a thing.

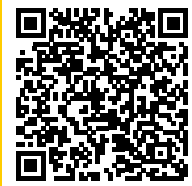

go.wagner-group.com/handwerk-newsletter

DIGITAL PRODUCT ADVISOR

GOOD ADVICE ALWAYS

Would you like to know which paint sprayer is best suited to your requirements? The digital product advisor can help you make the right choice. By answering five questions, you will receive exactly the results that match your selection in the shortest possible time. Try it out.



go.wagner-group.com/handwerk-produktberater

E-LEARNING

TIPS AND TRICKS FOR SPRAYING

In our "Online Professional Guide", we show you important tips and tricks for optimum handling and perfect spraying results. The online training only takes about 30 minutes and is perfectly tailored to your sprayer. Become UNSTOPPABLE and get your e-learning certificate!



go.wagner-group.com/e-learning-pf-en

SPRAYER EFFICIENCY CALCULATOR

WHEN WILL MY PURCHASE BE WORTHWHILE?

If you are thinking about buying a new or additional paint sprayer, you will certainly be asking yourself at what point the purchase becomes economically viable. The ROI calculator calculates your result with just a few entries and clicks. See for yourself.



go.wagner-group.com/roi-calculator

SPRAYMANAGER APP



**NEXT LEVEL
SPRAYING**

With the new **SprayManager app** from WAGNER, you become the hero of your everyday missions. Install now and get digital backing.



PROFESSIONALS WORK SMARTER

The new **SprayManager app** from WAGNER supports professional users such as tradesmen, consultants, salespeople and material manufacturers by providing information and advice on how to use spray systems of all brands.

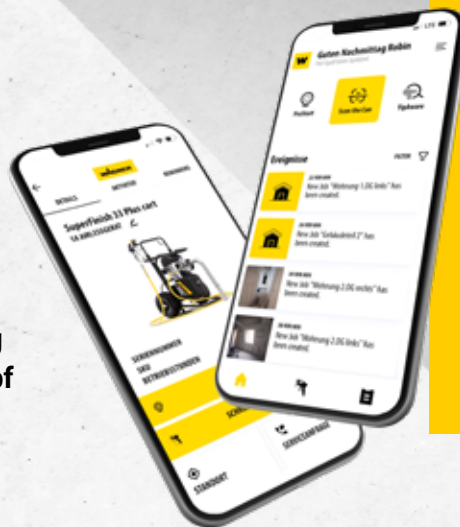

[go.wagner-group.com/
spraymanager-katalog](https://go.wagner-group.com/spraymanager-katalog)

READY FOR THE NEXT LEVEL?

Do you want to work even more efficiently with the **SprayManager app**? Then find out more about our new connective devices on the following pages here in the catalogue or at: spraymanager.io



HVLP/XVLP TURBINES

High air volume – low air pressure

Are you looking for a versatile spray device that offers a wide range of applications for improvement and renovation work on small to medium-sized construction sites? Then the modular low-pressure spray systems with HVLP- and XVLP technology (Xtra Volume Low Pressure) from WAGNER are perfect for you – especially in terms of quality, functionality and value for money. Low-pressure spraying involves working with a large air volume and a low air pressure (up to 0.7 bar) – which results in a high working speed and minimal overspray.



Particularly powerful and flexible:

In low-pressure spraying, the atomising air generated in the turbine flows through an air hose to the paint container on the spray gun, where it then builds up pressure. This delivers the coating material through the material tube to the nozzle and atomises it with the remaining air. The spray devices of the WAGNER XVLP series offer much better atomization performance compared to other lower-pressure devices (HVLP), thanks to a 60 percent greater air volume and 30 percent more surface coverage.

Well-equipped for daily use on construction sites:

The modular system consists of a turbine and various spray attachments which enables the application of wood stains, varnishes and lacquers through to emulsions with professional quality. Thanks to the practical Click & Paint function, the attachments can be changed with a simple movement. The XVLP devices from WAGNER are perfect when starting to use spray equipment or to add to the range of devices available on site.

1. LESS OVERSPRAY

The HVLP- and XVLP spray devices combine the positive properties of low pressure with those of a high-pressure procedure, i.e.: Less overspray and fine atomization result in an optimized consumption of material.

2. OPTIMAL ADJUSTMENT OPTIONS

The volume of air and material can be perfectly adjusted directly on the gun and therefore quickly changed to match various objects using a rotary control.

3. INNOVATIVE NOZZLE TECHNOLOGY

The XVLP spray devices combine the properties of low pressure with those of a high-pressure procedure. The combination of a large air volume and innovative, Visco slot nozzle technology enables a high working speed with excellent surface quality even with highly viscous paint.

4. A VARIETY OF POSSIBLE USES

The devices are especially versatile thanks to three spray attachments – StandardSpray, FineSpray and WallSpray – which are ideal for handling various materials. Thanks to the practical Click & Paint function, the spray attachments can be changed with a simple movement.

APPLICATION AREA ADVANTAGES HVLP AND XVLP TECHNOLOGY

Lacquers	Enamels		Emulsions
	standard	high-viscosity	
HVLP			
XVLP			

ADVANTAGES

- Easy to use
- Spray pattern adjustable to object
- Spraying of undiluted materials
- All settings directly on the gun
- Quick material change with Click & Paint system (XVLP)

FINISHCONTROL 3500 SPRAYPACK

All-rounder for small projects: The entry-level answer for professional coating with spray technology

The handy WAGNER paint sprayer is ideal for painting and fine finishing applications, touch-up and repair work as well as for small projects such as coating door panels and accent walls. FinishControl 3500 processes many materials such as solvent and water-based paints, stains, varnish, impregnations, oils and primers. With additional spray attachments, even emulsion paints can be applied.



The trend-setting Visco nozzle technology: produces a particularly high-quality spray pattern. This is achieved thanks to the flat jet delivered by the slot nozzle which also ensures a high working speed

Click & Paint System: the paint-carrying spray attachment can be easily removed from the gun for easy cleaning. Additional spray attachments allow you to work with different materials and change colours rapidly



Direct Spray Control: FinishControl is particularly easy to use. (1) The continuously adjustable air volume and the (2) material volume control ensure a precisely tailored approach to the material. (3) The spraying level and spray pattern width can be adjusted to suit the item being coated



High-performance turbine with a light weight: Start the turbine easily on the gun by pressing the trigger into the first level. Depress the trigger completely to start the material flow

SCOPE OF DELIVERY

Base unit FinishControl 3500	-
Spray attachment StandardSpray	2321879
Carrying case	2341100
Air filters, 3 pieces	2343947
Carrying strap	2341187
Fine riser tube filter	-
Rigid tube filter coarse	-
Cleaning brush	-

FINISHCONTROL 3500 2341501

TECHNICAL DATA

Voltage	230 V / 50 Hz
Motor output	700 W
Operating pressure, max.	0.2 bar, 0.02 MPa
Weight	3.5 kg

CORDLESS POWER

FREEDOM THROUGH BATTERY TECHNOLOGY



Powered by



WHAT IS THE ALLIANCE BATTERY FROM BOSCH?

AMPShare is the cross-brand battery platform from BOSCH Professional that allows professionals to switch flexibly between tools from different brands. As a partner, you can enjoy unlimited freedom of movement with our WAGNER battery-powered devices that are compatible with the AMPShare system.

THE RECHARGEABLE BATTERY FROM THE BOSCH PROFESSIONAL SERIES

One battery for all jobs: The 18V lithium-ion battery is a reliable partner for your construction sites. It can be used in all WAGNER cordless tools and also in many other 18V products from other manufacturers that are compatible with an AMPShare battery.

WHAT ARE THE ADVANTAGES OF WAGNER BATTERY-POWERED DEVICES?



Sustainable:

No additional batteries or chargers are required when purchasing additional devices - a big plus in terms of the environment, money and space.



Unlimited freedom of movement

Whether outside in the garden, on a building site or inside your home - you are more flexible than ever when realising your projects.



Brand and device flexibility:

Numerous products from different manufacturers can be operated with the same battery within the same system.



Always ready for action:

With a charged battery, your WAGNER device is always ready for use. For a longer runtime and more power, a larger battery with more ampere hours can also be used.



FINISHCONTROL 4000 18V STANDARDSPRAY

The mobile XVLV battery paint sprayer

The FinishControl 4000 18V cordless paint sprayer impresses with its unrestricted freedom of movement when coating smaller objects and other painting, repair and renovation work. With the StandardSpray spray attachment, FinishControl 4000 18V is the ideal partner for processing solvent and water-based paints. The excellent rechargeable batteries in combination with the brushless motor ensure optimized running time, a longer service life and optimum atomization performance.



Click & Paint system: to quickly change the spray attachment and for easy cleaning



StandardSpray spray attachment:
The ideal partner for processing solvent-based and water-based standard paints



Control panel: optimum operability and readability (filter warning, air volume regulation and battery indicator)

Compact and lightweight design:
with ergonomically balanced weight distribution for fatigue-free working

Brushless and efficient turbine:
Powerful, low-maintenance and compact

Vibration alarm: in the handle when the battery level is critical

Bosch Professional 18V AMPShare:
Flexibility thanks to a rechargeable battery system

SCOPE OF DELIVERY

Base unit FinishControl 4000 18V	-
Spray attachment StandardSpray	2430386
Fine riser tube filter	-
Rigid tube filter coarse	-
Cleaning set	2430409

FINISHCONTROL 4000 18 V STANDARDSPRAY 2453687

Scope of delivery as above, plus	
Bosch AMPShare 4Ah ProCore 18V battery (2 included in the kit)	2454461
Bosch charger GAL40-18V	2454460
L-Boxx 374 transport case with suspension kit	2454459

FINISHCONTROL 4000 18V STANDARD SPRAY KIT 2453688

TECHNICAL DATA

Voltage	370 W
Motor output	0.2 bar, 0.02 MPa
Operating pressure, max.	1.000 ml
Weight	1.3 kg (excl. battery) 1.9 kg (incl. battery)

FINISHCONTROL 4000 18V FINESPRAY

The mobile XVLV battery paint sprayer

The FinishControl 4000 18V cordless paint sprayer impresses with its unrestricted freedom of movement when coating smaller objects and other painting, repair and renovation work. With the FineSpray spray attachment, FinishControl 4000 18V is the ideal partner for processing low-viscosity paints and varnish. The excellent rechargeable batteries in combination with the brushless motor ensure optimized running time, a longer service life and optimum atomization performance.



Click & Paint system: to quickly change the spray attachment and for easy cleaning



FineSpray spray attachment: The ideal partner for processing low-viscosity paints and varnishes



Control panel: optimum operability and readability (filter warning, air volume regulation and battery indicator)

Compact and lightweight design: with ergonomically balanced weight distribution for fatigue-free working

Brushless and efficient turbine: Powerful, low-maintenance and compact

Vibration warning: in the handle when the battery level is critical

Bosch Professional 18V AMPShare: Flexibility thanks to a rechargeable battery system

SCOPE OF DELIVERY

Base unit FinishControl 4000 18V	-
Spray attachment FineSpray	2430385
Fine riser tube filter	-
Cleaning set	2430409

FINISHCONTROL 4000 18 V FINESPRAY 2437348

Scope of delivery as above, plus	
Bosch AMPShare 4Ah ProCore 18V battery (2 pieces included in the kit)	2454461
Bosch charger GAL40-18V	2454460
L-Boxx 374 transport case with suspension kit	2454459

FINISHCONTROL 4000 18V FINESPRAY KIT 2437240

TECHNICAL DATA

Voltage	370 W
Motor output	0.2 bar, 0.02 MPa
Operating pressure, max.	1.000 ml
Weight	1.3 kg (excl. battery) 1.9 kg (incl. battery)

FINISHCONTROL 5500

The all-round companion for perfect surfaces

FinishControl 5500 from WAGNER is the ideal choice when it comes to painting, touch-up or renovation work. Solvent or water-based paints, stains, varnish, impregnations, oils and primers can be used. With additional spray attachments, it is also possible to use emulsion paints, making the handy paint sprayer very versatile.



Click & Paint system: for quickly changing the spray attachment and easy cleaning

Direct Spray Control: precise and easy handling due to adjustable material and air volume, as well as the spray pattern, directly on the gun

Filter warning light: indicates when the filter needs cleaning or replaced

Integrated storage box: ideal for needles, air caps and the appropriate tools and cleaning accessories

Cup holder: Ideal for storing and transporting 1000 ml XVLP cups



XVLP gun & cup: Improved ergonomics, haptics and atomization

StandardSpray spray attachment: Pleasant to work with thanks to low spray mist and compact, extra-light design. The minimum number of components ensures easy cleaning and maintenance

Double air filter: Easily accessible and large filter surface for optimum atomization

SCOPE OF DELIVERY

Base unit FinishControl 5500	-
Air hose incl. handle, 5 m	2442011
XVLP Spray attachment StandardSpray	2430386
Cleaning kit	2430409
FINISHCONTROL 5500 SPRAYPACK	2422986

TECHNICAL DATA

Voltage	230 V / 50 Hz
Motor output	1.15 kW
Operating pressure, max.	0.29 bar, 0.029 MPa
Weight	6.6 kg

PRACTICAL ACCESSORIES FOR XVLP TURBINES

XVLP FINISHCONTROL SPRAY ATTACHMENTS

Art. No.

FineSpray, for low-viscosity paint and varnish	2430385
StandardSpray, for all standard paints	2430386
WallSpray, for emulsion and latex paints	2430387
Container, 1400 ml	2324749
Container, 1000 ml	2434525
Can adapter, for adapting original containers to the spray attachments	2350692



FineSpray spray attachment - for paints and varnishes

WallSpray spray attachment - for emulsion and latex paints



XVLP OTHER

Art. No.

Air filter, for FC 5500 and FC 9700, 4 pieces	2434505
Air filter, for FC 3500, 3 pieces	2343947
Air filter, for FC 4000 18V, 4 pieces	2454464
Fine riser filter, red, 5 pieces	2324248
Coarse riser filter, white, 5 pieces	2324249
Cleaning brush set	2430409
Nozzle seal, for FinishControl	2323934



StandardSpray spray attachment - for the application of standard paints



Cleaning brush set for cleaning hard-to-reach areas

FC 4000 ACCESSORIES

Art. No.

Transport box L-Boxx 374 incl. inlay	2454459
Battery AMPShare 18V 4AH ProCore	2454461
Charger Bosch GAL 18V-40	2454460
Set of inserts for L-Boxx 374	2454458

AMPShare 18V 4Ah ProCore - compact and powerful 18V battery for comfortable working. Fully compatible with tools from AMPShare alliance partners



L-Boxx 374 transport box incl. inlay - perfect transport protection with intuitive click system



FINECOAT 9700

The specialist for lacquer

The FineCoat 9700 fine spray system with HVLP technology is the new paint specialist from WAGNER. The powerful turbine enables a wide range of indoor and outdoor applications, which can be expanded with optional accessories. The solvent-resistant HVLP gun Ultra can be used to apply all standard solvent-based and water-thinnable paints.



HVLP Ultra Gun:

improved ergonomics and fine atomization

Precise adjustment of the spray pattern:

the spray jet can be perfectly adjusted to the object to be coated

Gun holder: for HVLP guns with gravity feed cup (gun with gravity feed cup available as separate accessory)

Integrated storage box: ideal for needles, air caps, tools and cleaning accessories

Filter warning light: indicates when the filter needs cleaning or replaced

Twin air filters: easily accessible filters with large surface for optimal atomization

Cup holder: for storage and transport of the HVLP gun with cup



SCOPE OF DELIVERY

Base unit FineCoat 9700	-
HVLP air hose, 7.6 m	2442013
HVLP FineCoat Gun Ultra	2435747
Cleaning kit	2430409

FINECOAT 9700 SPRAYPACK **2426601**

TECHNICAL DATA

Voltage	230 V / 50 Hz
Motor output	1.15 kW
Operating pressure, max.	0.3 bar, 0.03 MPa
Weight	6.8 kg

FINECOAT 9900 PLUS

High-performance HVLP coating specialist in a handy format

FineCoat 9900 Plus is the powerful WAGNER HVLP spray gun for a wide range of indoor and outdoor applications. The following water-soluble and solvent-based materials can be sprayed undiluted or adjusted to spray viscosity if required thanks to the powerful 5-stage turbine: Primers, impregnations, stains, varnish, varnishes, rust protection paints, radiator paints, textured paints, coloured effect paints and much more.



Precise adjustment of the spray pattern: directly on the gun. This way the pattern can be set precisely to the particular object to be coated

In a single operation: the air flow rate and the material flow rate can be regulated directly on the gun

Ergonomic gun build: the gun fits comfortably in the hand and is less tiring to use. In addition, the gun is very energy efficient

Quick-release coupling with integral swivel joint: for quick connection of the gun to the air hose

Practical holder: for the gun. During breaks in work and when transporting, the gun can be safely stored on the unit

Quick cleaning of the filter: take out the filter without tools, just briefly knock out or blow out and refit. Dirty filter warning light indicates if the filter has to be cleaned

Dual air filtration: one on the cooling side and another one on the atomizing side with an automotive type air filter with pre filter

Ultra-powerful: thanks to the 5-stage turbine



SCOPE OF DELIVERY

Base unit FineCoat 9900	-
Air hose FC 9900 Plus	277236
FineCoat gun, 1 liter pressure cup, incl. nozzle set No. 4	0277035B

FINECOAT 9900 PLUS SPRAYPACK 276048

TECHNICAL DATA

Voltage	230 V / 50 Hz
Motor output	1.5 kW
Operating pressure, max.	0.72 bar, 0.072 MPa
Weight	15 kg

PRACTICAL ACCESSORIES FOR HVLP TURBINES

HVLP GUNS	Art. No.
FineCoat Split Gun, flow cup, 600 ml	524053
FineCoat Split Gun, hanging cup, 1000 ml	524028
FineCoat gun, pressure cup 1 liter, incl.Nozzle set no. 4	0277035B
Conversion kit FC Split Gun to flow cup, 1000 ml	524045
Ultra Gun HVLP pistol	2435747
Pressure tank, for HVLP guns, 2 liters	524232

Split Gun - 600ml flow cup - for paints and varnishes

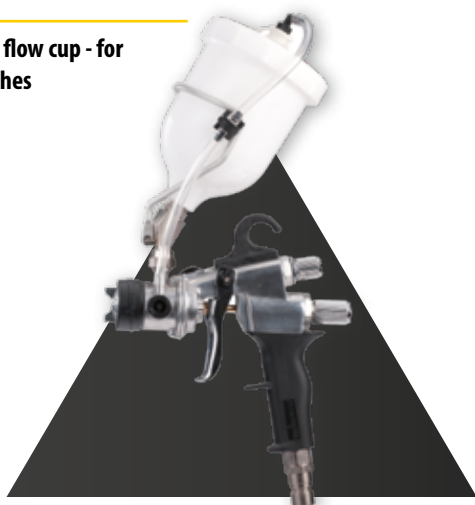

HVLP SPRAY NOZZLE SETS FOR FINECOAT SPLIT GUN	Art. No.
Spray nozzle set, no. 2, Ø 0.5 mm	529209
Spray nozzle set, no. 3, Ø 1.3 mm	529210
Spray nozzle set, no. 4, Ø 1.8 mm	529211
Spray nozzle set, no. 5, Ø 2.2 mm	529212
Spray nozzle set, no. 6, Ø 2.4 mm	529213

FineCoat hoses - Flexible and lightweight for comfortable hose handling



FINECOAT HOSES	Art. No.
Complete air hose, 9 m, for FC 9900 Plus	277236
Complete air hose, 7.6 m, for FC 9700	2442013
Hose assembly, DN10, 8.2m, for FineCoat	261255
Hose whip, 152cm, for FineCoat	0524405A

HVLP FILTER	Art. No.
Air filter, for FC 9700, 4 pieces	2434505
Air filter, for FC 9900 Plus, 2 pieces	279938

Air filter for FC 5500 and FC 9700

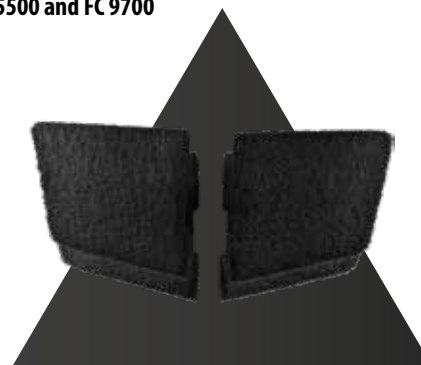

HVLP SPRAY NOZZLE SET FOR FINECOAT GUN	Art. No.
Spray nozzle set, no. 2, Ø 0.8 mm	276254
Spray nozzle set, no. 3, Ø 1.3 mm	276227
Spray nozzle set, no. 4, Ø 1.8 mm	276228
Spray nozzle set, no. 5, Ø 2.2 mm	276229
Spray nozzle set, no. 6, Ø 2.5 mm	276245
Spray nozzle set, no. 7, Ø 2.7 mm	524211

Spray nozzle set - for different materials

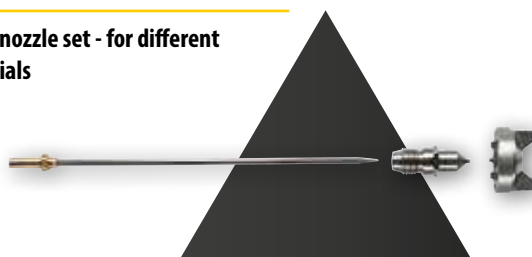

HVLP SPRAY NOZZLE SET FOR ULTRA GUN PISTOL	Art. No.
Spray nozzle set, no. 2, Ø 0.8 mm	2434549
Spray nozzle set, no. 3, Ø 1.3 mm	2434550
Spray nozzle set, no. 4, Ø 1.8 mm	2434551
Spray nozzle set, no. 5, Ø 2.2 mm	2434552
Spray nozzle set, no. 6, Ø 2.5 mm	2434553
Spray nozzle set, no. 7, Ø 2.7 mm	2434554



HEA – HIGH EFFICIENCY AIRLESS

Up to 55% less overspray with maximum control

Do you already value the advantages of airless technology, such as control and comfort? Then you'll be inspired by the new HEA ProTip airless nozzle from WAGNER. It achieves perfect surface results at a much lower spray pressure. Compared to conventional airless technology, you achieve a streak free coverage with softer spray edges.



More efficiency for prolonged working:

Thanks to the HEA nozzle technology, the spray pressure can be significantly lowered. This reduces the overspray by up to 55 percent*. Apart from reducing the amount of masking needed, this also has a positive effect on the gun's recoil. Working with a WAGNER airless pump is made even easier and more convenient with the HEA technology.

Robust and durable:

The nozzle wears more slowly due to the lower spray pressure. This means that HEA nozzles can be used for considerably longer than conventional airless nozzles. Loads on the pump are also reduced due to the lower pressure, with handling of the gun also improved.

1. MAXIMUM CONTROL:

The gentle spray pattern ensures a more even surface when overlapping the paths and avoids hard edges. This leads to a simple and easy-to-learn technique – even for inexperienced users.

2. PERFECT SURFACE QUALITY:

High Efficiency Airless ensures a uniform and even application on all surfaces and therefore offers excellent surface quality – especially when compared to conventional applications with a brush and roller.

3. INCREASED EQUIPMENT LIFESPAN:

Even the lifespan of the spray device itself is prolonged: the lower spraying pressure with High Efficiency Airless means that the system and its components are under less strain.



100 bar pressure
HEA ProTip 517

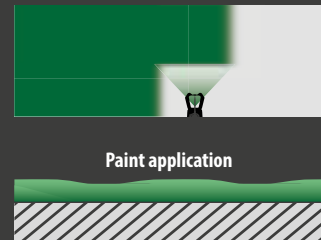

Paint application

Standard airless technology



150 bar pressure
Standard airless
nozzle 517

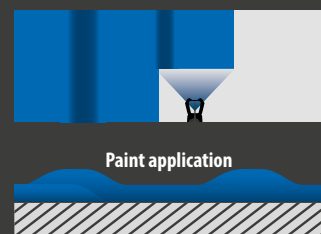

Paint application

*compared to other airless nozzles on the market

DIAPHRAGM PUMP

Effective material intake –
broad range of materials

Do you want to process different materials, from primers to silicate paints with just one device? Then a WAGNER diaphragm pump is the ideal choice. This powerful, maintenance friendly technology transports the material via a lifting motion of the diaphragm. Diaphragm pumps from WAGNER are robust, easy-to-use construction site and workshop units.

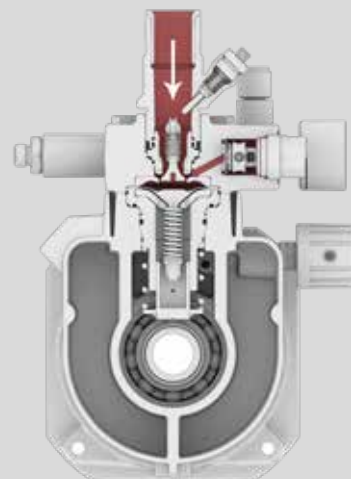

The perfect companion for painters and affiliated trades:

The patented Quality-Long-Stroke (QLS) technology from WAGNER, with its optimized hydraulics and special valve technology, means that the material is taken in much more effectively compared to diaphragm pumps from other manufacturers. As a result, a broad range of different materials, such as primers and release agents, primers and lacquers, emulsion and silicate paints, fabric adhesives, corrosion and flame retardants can be processed. In the domain of specially filled materials such as bitumen, fire protection and fillers, piston and spiral pumps are the specialists. Electrically operated diaphragm pumps can be used in both Airless and AirCoat processes with additional air atomization.

1. ALSO SUITABLE FOR VERY SMALL VOLUMES:

Diaphragm pumps have up to 58 %* less material in their system. The device's small cross-sections means that it can also be operated with tiny amounts of material. This saves resources both when changing material and during the cleaning process.

2. LOW-MAINTENANCE AND DURABLE:

The reduced lifting frequency of the diaphragm means that the already lower number of wear parts are placed under significantly less stress. This significantly reduces maintenance costs*. However, should a repair be necessary, the corresponding components can be easily replaced directly on site and in the case of both valves for example, within minutes.

3. FINE AND EVEN SPRAY PATTERN:

Diaphragm technology reduces the pulsation of the material flow, which avoids any irregularities in the spray pattern, remaining uniform and even.

SPRAYPATTERN AT LOW PRESSURE



Piston pumps:
irregular spray pattern



Diaphragm pump:
even spray pattern

BENEFITS

- Large range of material
- Flexible material intake(also small quantities)
- Fully adjustable pressure regulation from 0 - 25 MPa
- QLS technology with longer stroke
- Very fine, even spray pattern
- Robust and very low-maintenance
- Simple maintenance
- Low noise

*compared to other piston pumps on the market

SUPERFINISH 21 PRO HEA

Smallest WAGNER diaphragm pump for airless beginners with HEA technology

All the advantages of a compact diaphragm pump combined in a robust device for airless beginners - that is SuperFinish 21 Pro. The spray pack is ideal for processing emulsion and latex paints for medium-sized projects. With additional accessories, the SF 21 Pro can also be used as a wood and metal paint sprayer. The inlet and outlet valves are quick and easy to replace directly on site.



HEA 517 nozzle: for a soft spray pattern and up to 55 % less spray mist

Inlet & outlet valve: Quick and easy access to common wear parts to reduce downtime

Highly efficient and maintenance-free motor: Minimal electronics and very robust against voltage fluctuations



Solvent-resistant suction system: can be quickly converted to a hopper for small quantities

HEA pressure gauge: Smooth pressure regulation from 0-207 bar for maximum control. And a perfect surface finish

SCOPE OF DELIVERY

Base unit SF 21 Pro	-
Flexible intake system	2444485
HP hose DN6	2390608
HEA Pressure gauge combination	2383995
Airless gun Vector Pro	0538040
HEA ProTip 517	554517

SUPERFINISH 21 PRO HEA SPRAYPACK 2437311

TECHNICAL DATA

Voltage	230-240 V AC / 50 Hz
Motor output	0.9 kW
Operating pressure, max.	207 bar, 20.7 MPa
Delivery rate, max.	2.1 l/min
Nozzle size, max.	0.021"
Recommended hose length, max.	15 m
Viscosity, max.	15.000 mPas
Weight	23.6 kg

SUPERFINISH 21 PRO AIRLESS ENAMEL

Smallest WAGNER diaphragm pump for airless beginners - designed for wood and metal work

SuperFinish 21 Pro is the smallest diaphragm pump from WAGNER and is particularly suitable for airless beginners. The spray pack enables the application of wood and metal paints, primers, varnish, impregnations and oils and is ideal for medium-sized projects. With additional accessories, Superfinish 21 Pro can also be used as an emulsion sprayer. The compact design is beneficial as it requires minimal storage space for transportation. The inlet and outlet valve can be replaced quickly and easily directly on site.



TradeTip 3 FineFinish nozzle: for a perfect spray pattern and reduced wear

Inlet & outlet valve: Quick and easy access to common wear parts to reduce downtime

Highly efficient and maintenance-free motor: Minimal electronics and very robust against voltage fluctuations



3.7-liter hopper: ideal for small quantities of paint or frequent material changes

HEA pressure gauge: Smooth pressure regulation from 0-207 bar for maximum control and a perfect surface finish

SCOPE OF DELIVERY

Base unit SF 21 Pro	-
Hopper 3.7 liters	2444212
HP hose DN3	9984583
HEA Pressure gauge combination	2383995
Airless gun Vector Pro	0538040
TT3 FineFinish 410	554410

SUPERFINISH 21 PRO AIRLESS PAINT SPRAYPACK 2437312

TECHNICAL DATA

Voltage	230-240 V AC / 50 Hz
Motor output	0.9 kW
Operating pressure, max.	207 bar, 20.7 MPa
Delivery rate, max.	2.1 l/min
Nozzle size, max.	0.021"
Recommended hose length, max.	15 m
Viscosity, max.	15.000 mPas
Weight	23.6 kg

SUPERFINISH 23 PRO HEA

For perfect results with maximum control thanks to innovative airless diaphragm technology

The Spraypack is a robust, durable and reliable solution for perfect results. The flexible suction hose allows materials such as emulsion, latex paints or varnishes to be drawn directly from the original container. Transport is easy thanks to the foldable frame, which makes the SuperFinish 23 Pro ideal for space-saving transportation on the construction site. High reliability is guaranteed by the diaphragm pump technology: The SuperFinish 23 Pro is virtually maintenance-free, works reliably and continuously and can be operated with very small quantities of material.



Spray an outstanding surface quality:

The Vector

Pro airless gun is light in weight and has a long service life

Flexible suction hose for direct suction from the original container:

Strouble-free working - thanks to the special suction strainer with particularly fine meshes

HEA pressure gauge: The pressure of the sprayer can be checked at any time. HEA nozzles can also be used in the low pressure range (ideally at 80 - 140 bar). This area is marked in green on the pressure gauge

Tidy: Hoses can be conveniently stowed away thanks to the integrated hose holder

Comfortable: The height-adjustable telescopic handle enables easy transport on the construction site and space-saving storage of the appliance

Wide range of materials thanks to QLS - long-stroke technology: The optimized hydraulics and special valve technology make it possible

Robust design: Durable tyres make the SF 23 Pro the perfect partner on any construction site

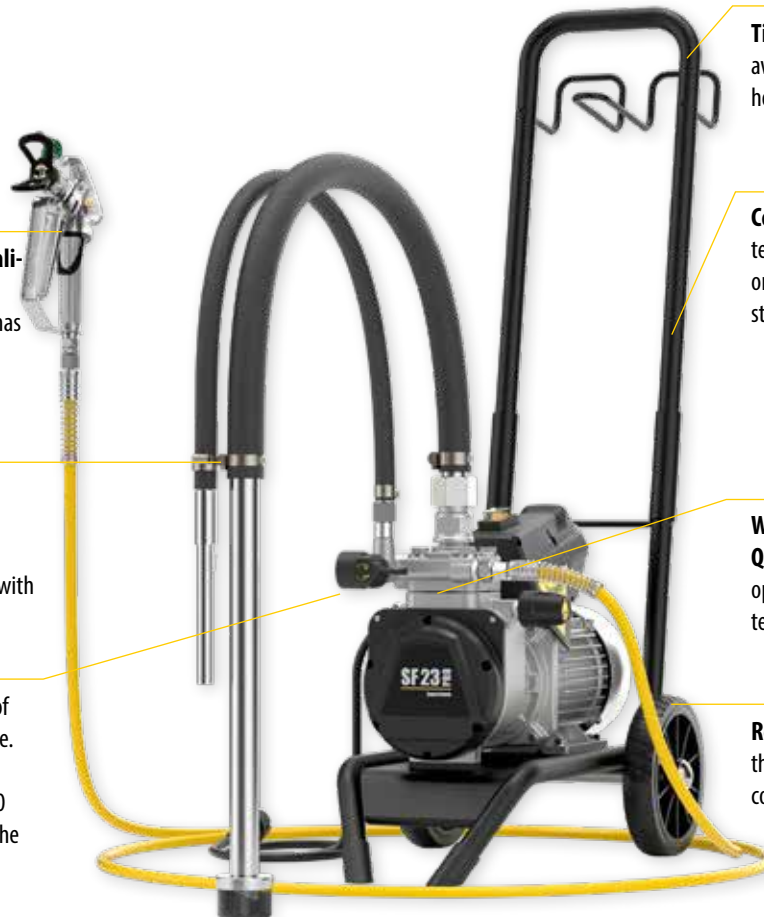

SCOPE OF DELIVERY

Base unit SF 23 Pro cart version	-
Suction system incl. return hose and filter	2393123
HP hose DN6	9984574
HEA Pressure gauge combination	2383995
Airless Vector Pro gun	538040
HEA ProTip, 519	554519
Tool bag, incl. wrench 41 mm/22 mm/19 mm and screwdriver	2391822

SUPERFINISH 23 PRO HEA SPRAYPACK 2399198

TECHNICAL DATA

Voltage	230 V / 50 Hz
Motor output	1.3 kW
Operating pressure, max.	250 bar, 25 MPa
Delivery rate, max.	2.6 l/min
Nozzle size, max.	0.023"
Recommended hose length, max.	30 m
Viscosity, max.	20.000 mPas
Weight	27 kg

SUPERFINISH 23 PLUS HEA

Compact – light and yet robust

The emulsion spray pack of the SuperFinish 23 Plus airless diaphragm pump is ideal for applying emulsion and exterior paints on medium-sized new build and renovation projects. With additional accessories, SuperFinish 23 Plus can also be used as a wood and metal paint sprayer. This is made possible by WAGNER's QLS long-stroke technology, which enables the application of low-viscosity paint, and varnishes and even high-viscosity emulsions. Even shear-sensitive products pose no problem.



Wide range of materials thanks to QLS - long-stroke technology: The optimized hydraulics and special valve technology make it possible

Multifunction switch for greater safety: On and off switch as well as circulation and spray mode. This prevents accidental switching on or off under pressure



Spray an outstanding surface quality: The Vector Grip airless gun is light in weight and has a long service life

Stepless pressure regulation: from 0 to 250 bar

Direct suction: Fine mesh filter prevents blockages. PumpRunner included for clean transportation

SCOPE OF DELIVERY

Base unit SF 23 Plus cart version	-
Suction system for SF 23 Plus incl. PumpRunner	2342879
HP hose DN6	9984574
HEA Pressure gauge combination	2383995
Airless Vector Grip gun incl. TradeTip 3 nozzle holder	538043
HEA ProTip, 519	554519
Gun filter white	34377

SUPERFINISH 23 PLUS HEA SPRAYPACK 2384153

TECHNICAL DATA

Voltage	230 V / 50 Hz
Motor output	1.3 kW
Operating pressure, max.	250 bar, 25 MPa
Delivery rate, max.	2.6 l/min
Nozzle size, max.	0.023"
Recommended hose length, max.	30 m
Viscosity, max.	20.000 mPas
Weight	29 kg

SUPERFINISH 23 PLUS AIRLESS ENAMEL

The perfect solution for small paint jobs using diaphragm technology

The SuperFinish 23 airless paint spray pack with FineFinish nozzle and hopper is ideal for applying paints, primers, varnish, impregnations, oils and greases for medium-sized new build and renovation projects. With additional accessories, SuperFinish 23 Plus can also be used as an emulsion device. This is made possible by WAGNER's QLS long-stroke technology, which enables the processing of low-viscosity materials from paints to high-viscosity emulsions.



Superb spray surface quality: with the Vector Grip Airless gun. Light in weight with a long service life

Large variety of materials with QLS long-stroke technology: the optimized hydraulics and special valve technology make it possible

Infinitely variable pressure regulation: from 0 to 250 bar

Multifunction switch for extra safety: on/off as well as circulation and spray mode. This prevents accidental switching on or off while the system is under pressure



SCOPE OF DELIVERY

Base unit SF 23 Plus cart version	-
Hopper 5 liter	341265
HP hose DN3	9984583
Airless gun Vector Grip incl. TradeTip 3 nozzle holder	538042
TradeTip 3 FineFinish nozzle 410	554410
Gun filter red	34383

SUPERFINISH 23 PLUS AIRLESS PAINT SPRAYPACK 2341492

TECHNICAL DATA

Voltage	230 V / 50 Hz
Motor output	1.3 kW
Operating pressure, max.	250 bar, 25 MPa
Delivery rate, max.	2.6 l/min
Nozzle size, max.	0.023"
Recommended hose length, max.	30 m
Viscosity, max.	20.000 mPas
Weight	29 kg

SUPERFINISH 23 PLUS TEMPSPRAY

Enamel specialist with heated hose

SuperFinish 23 TempSpray is ideal for the application of paints, primers, varnish, impregnations, oils and greases on medium-sized new build and renovation projects. With additional accessories, SuperFinish 23 Plus can also be used as an emulsion device. This is made possible by WAGNER's QLS long-stroke technology, which enables the processing of a wide range of materials, even shear-sensitive ones.



Perfect surface quality with Temp-Spray: thanks to warming up the coating material a very soft spray pattern is generated. This increases the atomization quality. Further advantages are reduced overspray, perfect viscosity without diluting and much more

Large variety of materials with QLS long-stroke technology: the optimized hydraulics and special valve technology make it possible

Superb Spray Surface Quality: with the Vector Grip Airless gun. Light in weight with a long service life

Infinitely variable pressure regulation: from 0 to 250 bar

Multifunction switch for extra safety: on/off as well as circulation and spray mode. This prevents accidental switching on or off while the system is under pressure



SCOPE OF DELIVERY

Base unit SF 23 Plus cart version	-
Hopper 5 liter	341265
TempSpray H 126 base unit	2311659
HP hose DN3	9984583
Airless Vector Grip gun incl. TradeTip 3 nozzle holder	538043
TradeTip 3 FineFinish nozzle 410	554410
Gun filter red	34383

SUPERFINISH 23 PLUS AIRLESS PAINT SPRAYPACK 2341496

TECHNICAL DATA

Voltage	230 V / 50 Hz
Motor output	1.3 kW
Operating pressure, max.	250 bar, 25 MPa
Delivery rate, max.	2.6 l/min
Nozzle size, max.	0.023"
Recommended hose length, max.	10 m
Viscosity, max.	20.000 mPas
Weight	29 kg

SUPERFINISH 23 PLUS AIRCOAT ENAMEL

Mobile complete solution for enamel work

The WAGNER SF 23 Plus AirCoat spray pack is ideal for particularly high-quality surface coating of lacquers and varnishes and is therefore ideally suited for woodworking. The spray pack is equipped with the ergonomic WAGNER AC 4600 AirCoat gun incl. nozzle, as well as an HD double hose.

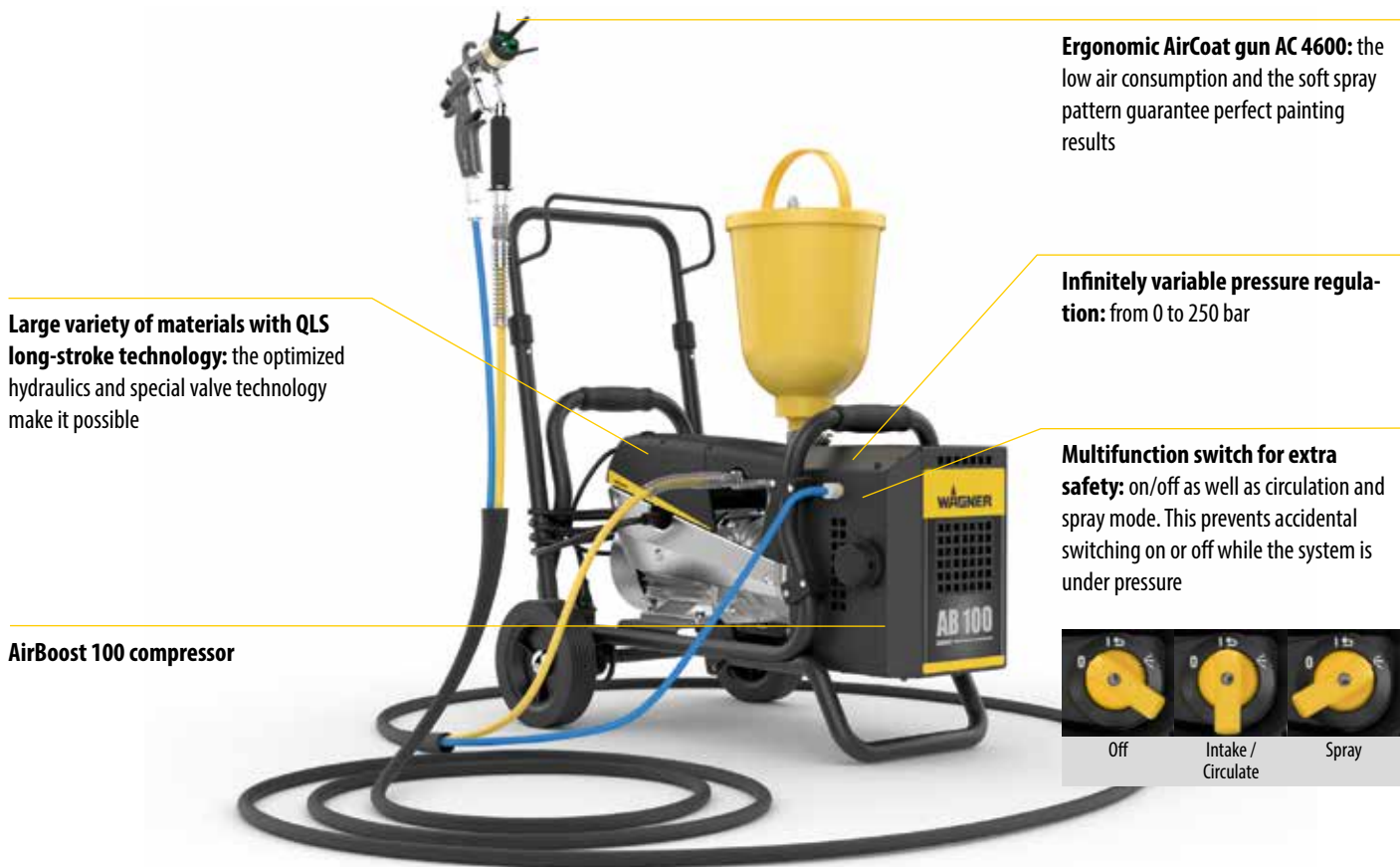

Large variety of materials with QLS long-stroke technology: the optimized hydraulics and special valve technology make it possible

Ergonomic AirCoat gun AC 4600: the low air consumption and the soft spray pattern guarantee perfect painting results

Infinitely variable pressure regulation: from 0 to 250 bar

Multifunction switch for extra safety: on/off as well as circulation and spray mode. This prevents accidental switching on or off while the system is under pressure

AirBoost 100 compressor



SCOPE OF DELIVERY

Base unit SuperFinish 23 Plus cart version	-
Hopper 5 liter	341265
HP double hose DN4	2302379
AirCoat gun AC 4600	394155
Nozzle ACF3000	379411
Green air cap	394912
AirBoost 100 compressor	2347935
AirCoat regulator	340250

SUPERFINISH 23 PLUS AIRCOAT LACQUER SPRAYPACK 2353393

TECHNICAL DATA

Voltage	230 V / 50 Hz
Motor output	1.3 kW
Operating pressure, max.	250 bar, 25 MPa
Delivery rate, max.	2.6 l/min
Nozzle size, max.	0.023"
Recommended hose length, max.	7.5 m
Viscosity, max.	20.000 mPas
Weight	29 kg

SUPERFINISH 23 CR

Professional injection and crack repair

Thanks to its robust design, the SuperFinish 23 CR is one of the most reliable pumps of its kind. Service, cleaning and maintenance can be carried out directly on site thanks to fewer electronic components. Thanks to a wide range of accessories, such as flexible and rigid suction systems and a hopper, the two-position cart offers maximum flexibility in application areas.



**NO
SPRAYPACK -
ACCESSORIES
NECESSARY**



Hopper for small quantities



Flexible suction system



Rigid suction system with rigid return hose



Rigid suction system with flexible return hose

Inlet pusher valve: for a high operating reliability and easy commissioning. Just the press of a finger, and the valve is free

Pressure relief directly at the unit: stainless steel ball valve - especially for injection application

Fine adjustment: Smooth pressure regulation from 0-250 bar for all applications

Long-stroke technology from WAGNER: thanks to a low stroke frequency, the components are subjected to significantly less stress and thus offer a longer service life and lower maintenance costs

Brushless motor: maintenance free and completely reliable

Easy to transport: robust cart with height-adjustable handle

Modular variants: two-position cart for use with hopper, flexible and rigid suction system



SCOPE OF DELIVERY

Base unit SF 23 CR cart version	-
Pressure gauge set HEA	2383995
SUPERFINISH 23 CR	2415601

ACCESSORIES FOR INJECTION WORK

Hose whip with mouthpiece	2434357
Hopper 5 liter, M36x2	2357506
Suction system, flexible	2393123
Suction system, rigid, with flexible return hose	2405950
Suction system, rigid, with rigid return hose	2429697
Airless gun AG 14, G-thread 1/4", incl. TradeTip 3 nozzle holder	0502081A

TECHNICAL DATA

Voltage	230 V / 50 Hz
Motor output	1.3 kW
Operating pressure, max.	250 bar, 25 MPa
Delivery rate, max.	2.6 l/min
Nozzle size, max.	0.023"
Recommended hose length, max.	15 m
Viscosity, max.	20.000 mPas
Weight	29 kg

SUPERFINISH 33 PRO

One diaphragm pump for every project – outstanding performance for in- and outdoor application

The unique QLS long-stroke technology makes it possible to reliably process low-viscosity paints, emulsions and even highly viscous corrosion protection. SuperFinish 33 Pro is therefore a must for any painter working on large projects. The diaphragm pump is reliable and particularly low-maintenance, thanks to inlet valves with a three times longer service life and improved cooling for reduced wear.



Ergonomic work: with the Airless gun Vector Pro. It is light and robust

Easy to transport: robust cart with height-adjustable handle

Inlet pusher valve: for a high operating reliability and easy commissioning. Just the press of a finger, and the valve is free

Large variety of materials with QLS long-stroke technology: the optimized hydraulics and special valve technology make it possible

Robust, building-site-friendly tyres: allow easy transport across even the most challenging terrain

SCOPE OF DELIVERY

Base unit SuperFinish 33 Pro	-
Suction system, flexible	34630
HP hose DN6	9984574
Airless Vector Pro gun, incl. TradeTip 3 nozzle holder	0538040
HEA ProTip 521	554521

SUPERFINISH 33 PRO SPRAYPACK 2388260

TECHNICAL DATA

Voltage	230 V / 50 Hz
Motor output	2.2 kW
Operating pressure, max.	250 bar, 25 MPa
Delivery rate, max.	4.3 l/min
Nozzle size, max.	0.033"
Recommended hose length, max.	60 m
Viscosity, max.	25.000 mPas
Weight	43 kg

SUPERFINISH 33 PLUS

The extremely easy-to-use diaphragm pump for every project

With a maximum flow rate of 4.3 liters per minute, SuperFinish 33 is the most powerful airless diaphragm pump from WAGNER. Equipped with QLS long-stroke technology, SuperFinish 33 can reliably process many materials, from low-viscosity paints and emulsions to high-viscosity corrosion protection. SuperFinish 33 Plus is therefore a must for any painter working on large-scale projects.



Ergonomic working: with the high-quality Vector Grip airless gun. It is lightweight, robust and particularly ergonomic

Includes practical 230 V socket: for connecting additional devices, such as TempSpray

Modular variants: Two-position trolley for use with hopper or rigid suction system



High reliability: through inlet valve pushers. One press of the thumb and the valve is free

Illuminated multifunctional switch for greater safety: On and off switch as well as circulation and spray mode. This prevents accidental switching on or off under pressure



Tires suitable for construction sites: They enable you to transport them easily over the most difficult construction sites

Integrated tool box: incl. practical organizer. Guarantees that the right tools and accessories are always to hand



Direct suction: Trouble-free work due to special fine filter mesh which prevents blockages

SCOPE OF DELIVERY

Base unit SuperFinish 33 Plus	-
Suction system, rigid	2370310
HP hose DN6	9984574
Airless Vector Grip gun, incl. TradeTip 3 nozzle holder	0538043
HEA ProTip 521	554521
SUPERFINISH 33 PLUS SPRAYPACK	2388259

TECHNICAL DATA

Voltage	230 V / 50 Hz
Motor output	2.2 kW
Operating pressure, max.	250 bar, 25 MPa
Delivery rate, max.	4.3 l/min
Nozzle size, max.	0.033"
Recommended hose length, max.	60 m
Viscosity, max.	25.000 mPas
Weight	50 kg

PRACTICAL ACCESSORIES FOR ELECTRIC DIAPHRAGM PUMPS

ENAMEL KIT (DN4) FOR ALL SUPERFINISH PUMPS

ENAMELKIT (DN4)

FOR SUPERFINISH PUMPS

(SF21, SF 23, SF 33, SF 27, SF 31)

2406207

HP hose DN4, NPSM 1/4", max 27 MPa / 270 bar, 7.5 m

Vector Pro pistol

Nozzle extension, G-thread, 12.5 cm

FineFinish TT3 nozzle 308 (enamel)

FineFinish TT3 nozzle 412 (filler)

TipClean 200 ml

Plug-in filter, red, extra fine, 10 pieces

Hopper set 5 liters, M36 x 2



HEA KIT (DN6) FOR ALL PUMPS WITH 1/4" CONNECTIONS

HEA KIT (DN6)

FOR ALL PUMPS WITH 1/4" CONNECTIONS

(ALL SUPERFINISH AND PROSPRAY PUMPS, AS WELL AS THE POWERPAINTER 90)

2408212

HP hose DN6, NPSM 1/4", max. 27 MPa / 270 bar, 15 m

Vector Pro pistol

Nozzle extension, G-thread, 15 cm

HEA ProTip nozzle 517

HEA ProTip nozzle 311

TipClean 200 ml

Gun filter, white, medium, 10 pieces



2GUN KIT - FOR CONNECTING UP TO THREE GUNS TO ONE DEVICE

2GUN KIT

FOR CONNECTING UP TO 3 GUNS TO ONE DEVICE

(SF33, PS 3.31 upwards and HeavyCoat pumps)

2413598

Distributor adapter (for max. three guns)

Vector grip gun

HP hose DN6

Double connector NPSM 1/4"



ACCESSORIES FOR AIRCOAT

Art. No.

AirCoat gun AC 4500, incl. blue air cap and holder	2368269
AirCoat nozzles ACF 3000, various. Sizes	379xxx
HD double hose, material DN3, max. 27 MPa, air DN6, 1/4", 7.5 m	9984595
Air cap blue, incl. union nut	394911
Air cap green, incl. union nut	394912
Air cap red, incl. union nut	394910
Union nut complete	394921
AirBoost 100 compressor	2347935
AirCoat regulator, mounting kit	340250

HOPPER

Art. No.

Hopper 20 liters, M36x2, for SuperFinish	341266
Hopper 5 liters, M36x2, for SuperFinish	341265
Hopper 5 liters, with TopClean, for SuperFinish	341268
Hopper 3.7 liters, for SuperFinish 21 Pro	2444212

NOTES

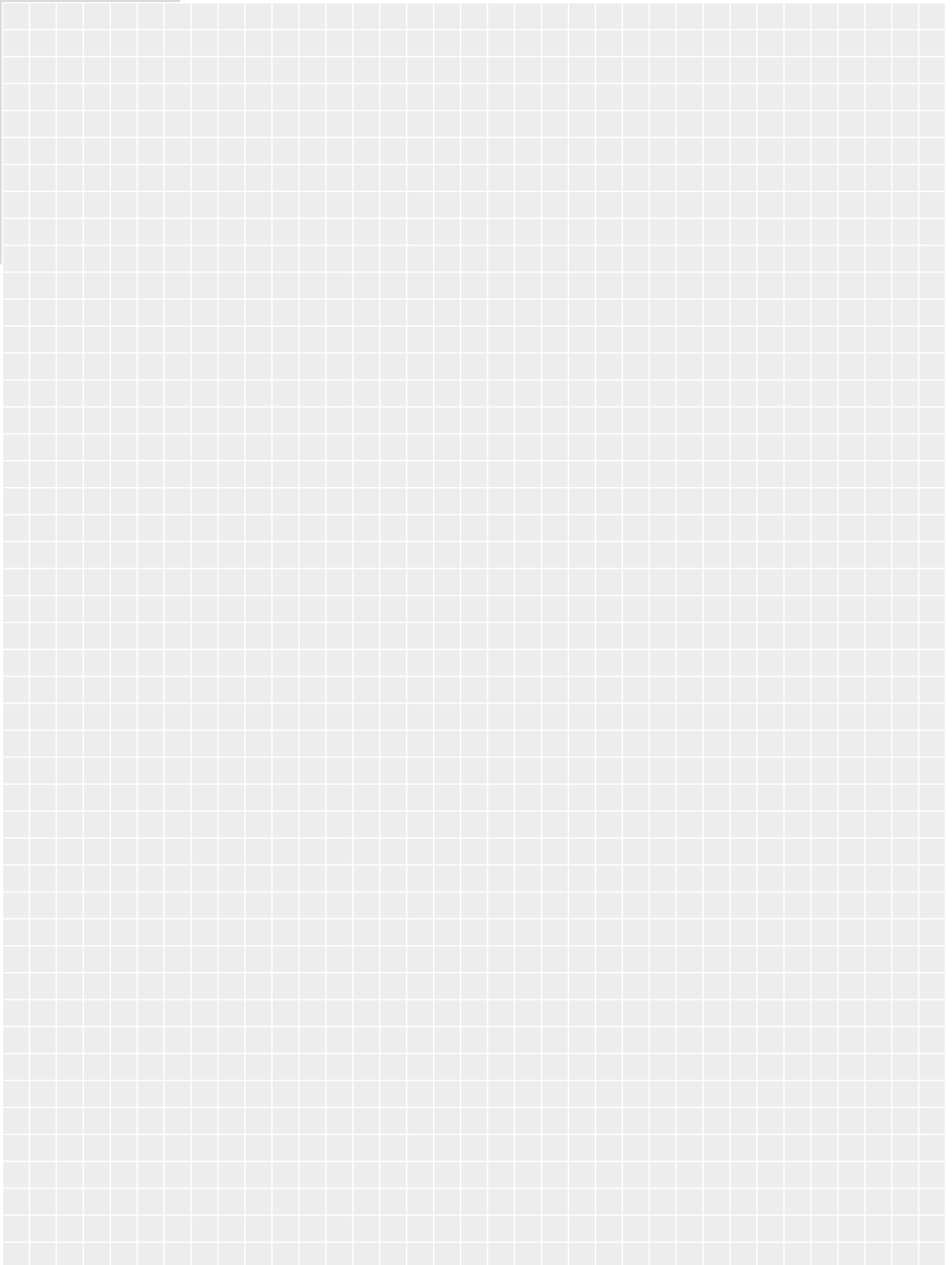

ELECTRIC PISTON PUMPS

Especially high suction and delivery performance – across the range

Do you mostly work with viscose or filler materials? Then an electric WAGNER piston pump is the best support for you. The high suction power produced by the piston's lifting motion makes it ideal for this type of material.

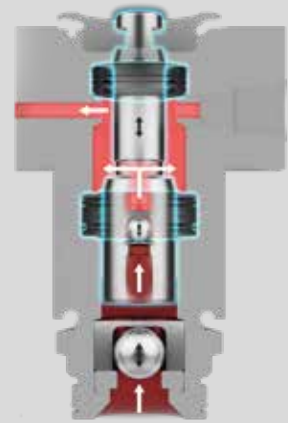

Various performance classes for professional and semi-professional users:

With the third generation of piston pumps from WAGNER, you have a choice of machines for large or small sites. They cover a broad range of paints and emulsions - right through to high-viscosity and filler materials for interior and exterior use.

A powerful companion - inside and out:

WAGNER piston pumps are available with three different drive systems. Electric piston pumps cover a wide range of performance classes and have a compact design. The hydraulic piston pumps offer even better performance and are available with a choice of either a petrol or an electric motor which can be switched in a few minutes. Pneumatically driven piston pumps from WAGNER are explosion-proof and therefore are suitable for use in workshops.

1. BRUSHLESS MOTOR:

Brushless motors are a real benefit for this device, especially in terms of its long service life. Alongside its efficient mode of working, its key advantages include a constantly high torque with low power consumption and reduced heat generation.

2. NO CONTINUOUS RUNNING:

Piston pumps only operate when you have to build up pressure. The rest of the time, the drive is on 'standby'. This protects wear parts and has a positive impact on site noise levels.

CROSS-SECTION OF THE PISTON

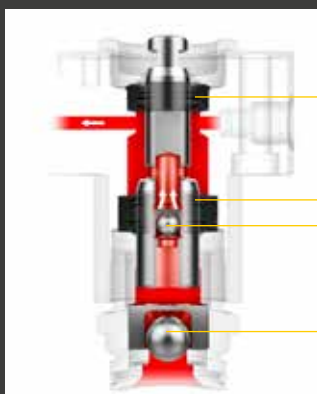

ADVANTAGES

- Powerful suction
- Better delivery capacity with high viscosity materials
- Less sensitive to filled materials
- Large nozzle sizes can be used
- Extra-durable packing

PISTON PUMPS WITH INTELLISYNC TECHNOLOGY

For professionals who work smarter

WAGNER's connected ProSpray Connect piston pumps with IntelliSync technology enable a wireless connection between the sprayer and the SprayManager app via Bluetooth. This means you can use even more functions of the app and receive the best digital support when using your paint sprayer.



IntelliSync - Digital interface:

The SprayManager app and IntelliSync make it easy to connect WAGNER devices. Devices with IntelliSync automatically appear in the "MyFleet" area of the SprayManager app. A large, illuminated Bluetooth symbol on the top of the device indicates the connection status. IntelliSync ensures a reliable and secure wireless connection for complete control over the airless device, whether the user is next to the machine or on scaffolding.



ProStart

ProStart - Perfect work preparation:

Getting started is easy! ProStart conveniently guides you through every step work processes, from setup to documentation. When using ProStart with a connected airless device, the app automatically applies the correct pump settings. During the job, the pump can be controlled via a smartphone - no matter where it is.



MyFleet

My Fleet - Fleet management:

Managing multiple sprayers can be challenging, making it difficult to monitor their usage, operation times, and condition. MyFleet offers comprehensive fleet oversight, applicable to devices from any manufacturer. Piston pumps featuring IntelliSync can be easily integrated into the fleet, enabling automatic tracking of operation times and the generation of service reminders based on material usage. For non-connected devices, maintenance records can be manually updated.



TipAware

TipAware - nozzle wear indicator:

Worn nozzles consume too much material and provide a poor spray pattern. Unfortunately, nozzle wear is not visible from the outside. TipAware simplifies this issue functioning like a battery tester. All you have to do is insert a nozzle into the gun and spray water into a bucket for approx. 30 seconds. The status of the nozzle is displayed in real time. TipAware is included in ProStart and shows you the nozzle quality in real time while you are working.



Scan the Can

Scan the Can - Automatic material recognition

Can my material be sprayed and if so, how do I optimize the device settings? Scan the Can displays all this information in a clear overview in seconds. Simply take a photo of the container and the app automatically provides all relevant processing information such as nozzle size, spray pressure and dilution. Click again to open the product data sheet directly.



MyWork

MyWork - Job documentation:

While ProStart automatically compiles all processes, manual data entry is also an option. This eliminates the need for handwritten reports, streamlining handovers without the need for detailed briefings, thereby enhancing team efficiency and reliability.

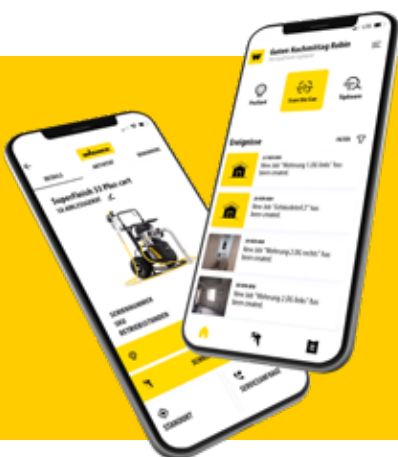

With the new **SprayManager** app from WAGNER, you become the hero of your everyday missions. Install now and get digital backing.



go.wagner-group.com/spraymanager-katalog

POWERPAINTER 90 EXTRA

Fast, clean, perfect – the airless paint spraying system for small projects

The PowerPainter 90 Extra mobile airless paint sprayer is ideal for painters and tradespeople looking for an easy-to-use sprayer for smaller projects. PowerPainter 90 Extra is the smallest paint sprayer from WAGNER with an output of over 200 bar. The WAGNER paint sprayer is supplied as a ready-to-use spray pack and is equipped with the innovative High Efficiency Airless technology (HEA).



Comfortable: the adjustable telescopic handle allows convenient transportation on the construction site and space-saving storage

Pressure gauge: allows the perfect control of pressure in coordination with the material being processed

DN6, 15 m high-pressure hose: for a large radius of action

Integrated storage box: ideal for storing tools and accessories

Innovative HEA nozzle technology: two nozzle orifices, one directly in front of the other, guarantee a perfect spray pattern with high material throughput even in low pressure ranges

Lightweight airless gun with four-finger trigger: for fatigue-free and safe work

Double-Acting-piston pump: for consistent material feed

Inlet pusher valve: for a high operating reliability and easy commissioning. Just the press of a finger, and the valve is free

Also available as skid-version



SCOPE OF DELIVERY

Base unit PowerPainter 90 Extra	-
Airless Vector Pro gun incl. TradeTip 3 nozzle holder	538040
HP hose DN6	2390608
Pressure gauge set HEA	2383995
HEA ProTip 517	554517
EasyGlide special oil	508619

POWERPAINTER 90 EXTRA SKID SPRAYPACK	2414079
POWERPAINTER 90 EXTRA CART SPRAYPACK	2401275

TECHNICAL DATA

Voltage	230 V / 50 Hz
Motor output	0.8 kW
Operating pressure, max.	200 bar, 20 MPa
Delivery rate, max.	1.9 l/min
Nozzle size, max.	0.019"
Recommended hose length, max.	15 m
Weight	10.2 kg / 18 kg

NOTES

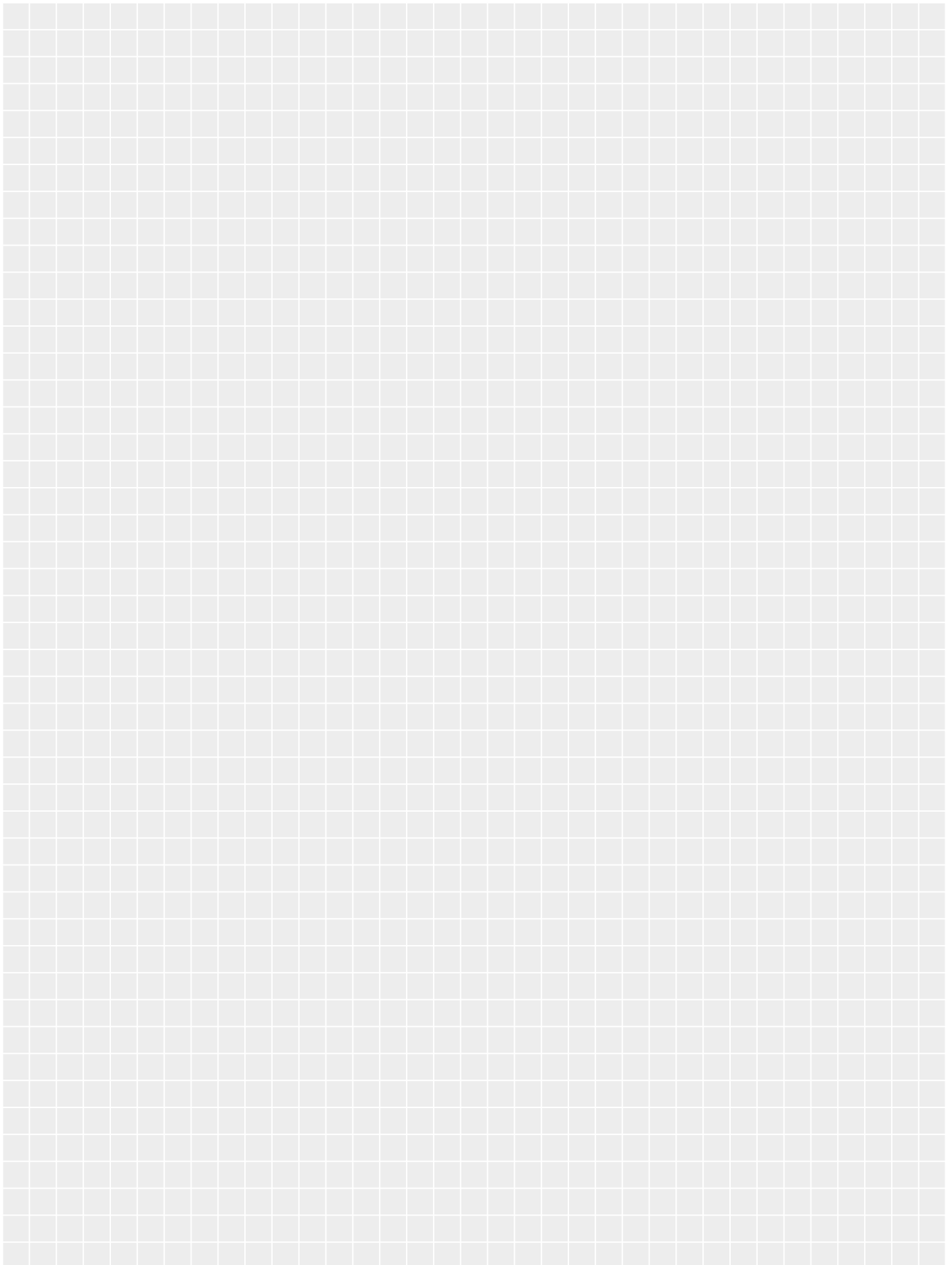

PROSPRAY 3.20 HEA

The compatible piston pump for airless beginners

The ProSpray 3.20 is an airless paint sprayer ideal for beginners and suitable for coating small items such as doors, door frames, railings, furniture, wood paneling, fences, radiators, and metal objects. It can also process emulsion paints for indoor use. This WAGNER sprayer comes as a complete spray pack, equipped with innovative High Efficiency Airless (HEA) technology.



Included: tool bag with two spanners

HEA 517 nozzle: for a soft spray pattern and up to 55 % less overspray

User-friendly: easy to operate and a reduced number of settings options makes starting up the sprayer easier

HEA pressure gauge: a longer service life thanks to innovative HEA low-pressure airless technology

Hose wrap: for optimized storage of the hose

Inlet pusher valve: for a high operating reliability and easy commissioning. Just the press of a finger, and the valve is free

Double-acting-piston pump: for consistent material feed



SCOPE OF DELIVERY

Base unit ProSpray 3.20	-
Flexible suction system	0558672A
HP hose DN6	2390608
Pressure gauge set HEA	2383995
Airless Vector Pro gun, incl. TradeTip 3 nozzle holder	0538040
HEA ProTip 517	554517
PROSPRAY 3.20 HEA SPRAYPACK	2412438

TECHNICAL DATA

Voltage	230 V / 50 Hz
Motor output	1.3 kW
Operating pressure, max.	207 bar, 20.7 MPa
Delivery rate, max.	2 l/min
Nozzle size, max.	0.021"
Recommended hose length, max.	30 m
Viscosity, max.	2.000 mPas
Weight	13.6 kg

PROSPRAY 3.21 HEA

Small and compact – for small object sizes

For all airless beginners looking for a sprayer for coating small objects such as doors, railings, furniture, wood paneling, fences, radiators, and metal objects, as well as interior walls and exteriors, the Airless piston pump ProSpray 3.21 HEA from WAGNER is ideal. It reliably processes paints, primers, oils and emulsions.



Maintenance made easy: with the push of a button the piston is oiled and thus the packings are conserved

HEA pressure gauge: a longer service life thanks to innovative HEA low-pressure airless technology

HEA 517 nozzle: for a soft spray pattern and up to 55 % less overspray

Compact: for easy transportation and space-saving storage

DN6, 15 m high-pressure hose: for a large radius of action

Inlet pusher valve: for a high operating reliability and easy commissioning. Just the press of a finger, and the valve is free



SCOPE OF DELIVERY

Base unit ProSpray 3.21	-
Flexible suction system	0558672A
HP hose DN6	9984574
Pressure gauge set HEA	2383995
Airless Vector Grip gun, incl. TradeTip 3 nozzle holder	0538040
HEA ProTip 517	554517
PROSPRAY 3.21 HEA SPRAYPACK	532089

TECHNICAL DATA

Voltage	230 V / 50 Hz
Motor output	1.035 kW
Operating pressure, max.	221 bar, 22.1 MPa
Delivery rate, max.	2 l/min
Nozzle size, max.	0.023"
Recommended hose length, max.	30 m
Viscosity, max.	20.000 mPas
Weight	17.9 kg

PROSPRAY 3.25

A compact emulsion unit for medium-sized objects

The WAGNER Airless ProSpray 3.25 is ideally equipped for medium-sized emulsion projects and adhesive applications. With additional accessories, it can also process water and solvent-based paints, two-component coating materials, release agents, oils, primers, undercoats, and fillers. Thanks to the tires suitable for construction-sites, this airless paint sprayer is an ideal companion even on difficult terrain.



Clearly arranged - DESC-Control: with the digital display you can read out and handle machine data, consumption figures, runtimes and much more. The intelligent deadband control, SlowMotion function and FrequentClean guarantee trouble-free work and quick cleaning

Maintenance-free, brushless direct current motor: due to the improved performance, the motor works even more efficiently at low and also at high speeds. The continuous paint pressure measurement controls the motor speed automatically, thus ensuring a constant material pressure



HEA nozzle: for a soft spray pattern and up to 55 % less overspray

Superb spray surface quality: with the Vector Grip Airless gun. Light in weight with a long service life

Maintenance made easy: with the push of a button the piston is oiled and thus the packings are conserved

Inlet pusher valve: for a high operating reliability and easy commissioning. Just the press of a finger, and the valve is free

SCOPE OF DELIVERY

Base unit ProSpray 3.25 cart version	-
HP hose DN6	9984574
Airless Vector Grip gun, incl. TradeTip 3 nozzle holder	0538043
HEA ProTip 519	554519
PROSPRAY 3.25 SPRAYPACK	2308260

TECHNICAL DATA

Voltage	230 V / 50 Hz
Motor output	1.1 kW
Operating pressure, max.	221 bar, 22.1 MPa
Delivery rate, max.	2.6 l/min
Nozzle size, max.	0.027"
Recommended hose length, max.	30 m
Viscosity, max.	25.000 mPas
Weight	27.4 kg

PROSPRAY 3.25 CONNECT

Connective piston pump for medium-sized projects with digital backing

WAGNER ProSpray 3.25 Connect is one of the first connected airless paint sprayers on the market. The device can be easily connected and controlled with the SprayManager app via Bluetooth. The paint sprayer is ideally equipped for medium-sized emulsion and adhesives work. Robust packings, an inlet valve pusher, the brushless motor and automatic oiling guarantee low-maintenance operation. The DigiTrac Control digital display allows machine data, consumption values, running times and much more to be read out.



Digi-Trac-Control System: processes machine data, consumption values, running times and much more digitally. Intelligent deadband control, slow motion function and frequency clean for trouble-free operation and fast cleaning

IntelliSync unit: Establishes a Bluetooth connection between the sprayer and the SprayManager app

Brushless motor: maintenance-free and reliable

HEA nozzle: For a uniform spray pattern with little spray mist, even in low pressure ranges

Airless gun Vector Grip: light, durable and particularly ergonomic

Rigid suction system: smooth operation directly from the original container

Inlet valve pusher: for high operational reliability, simply push the valve free



SCOPE OF DELIVERY

Base unit ProSpray 3.25 Connect	-
HP hose DN6	9984574
Airless Vector Grip gun, incl. TradeTip 3 nozzle holder	0538043
HEA ProTip 519	554519
PROSPRAY 3.25 CONNECT SPRAYPACK	2420182

TECHNICAL DATA

Voltage	230 V / 50 Hz
Motor output	1.1 kW
Operating pressure, max.	221 bar, 22.1 MPa
Delivery rate, max.	2.6 l/min
Nozzle size, max.	0.027"
Recommended hose length, max.	30 m
Viscosity, max.	25.000 mPas
Weight	27.4 kg

PROSPRAY 3.31

A reliable unit for large-area emulsion work

The WAGNER Airless ProSpray 3.31 is ideal for large emulsion projects on new construction sites and for renovation projects. The spray pack is perfectly tailored for processing emulsion and latex paints. With additional accessories, water and solvent-based lacquers, two-component coating materials, release agents, oils, undercoats, primers, and fillers can also be processed.



No nozzle blockages: the high pressure filter is easily accessible and quick to clean. Three different filter inserts (fine, medium, coarse) ensure an optimal match with the material

Superb spray surface quality: with the Vector Grip Airless gun. Light in weight with a service life

Tilting cart: fast change of the container. Site-optimized tires allow convenient sprayer transportation

Clearly arranged - DESC-Control: with the digital display you can read out and handle machine data, consumption figures, runtimes and much more. The intelligent deadband control, SlowMotion function and FrequentClean guarantee trouble-free work and quick cleaning

Maintenance-free, brushless direct current motor: due to the improved performance, the motor works even more efficiently at low and also at high speeds. The continuous measurement of paint pressure automatically controls the motor speed to maintain a constant material pressure



SCOPE OF DELIVERY

Base unit ProSpray 3.31	-
HP hose DN6	9984574
Airless Vector Grip gun, incl. TradeTip 3 nozzle holder	0538043
HEA ProTip 521	554521
PROSPRAY 3.31 SPRAYPACK	2308262

TECHNICAL DATA

Voltage	230 V / 50 Hz
Motor output	1.84 kW
Operating pressure, max.	221 bar, 22.1 MPa
Delivery rate, max.	3.8 l/min
Nozzle size, max.	0.032"
Recommended hose length, max.	60 m
Viscosity, max.	25.000 mPas
Weight	43.5 kg

PROSPRAY 3.31 CONNECT

Connective piston pump with innovative operating concept

The WAGNER ProSpray 3.31 Connect airless device takes spraying to a new level. Thanks to IntelliSync, the device can be easily connected to the SprayManager app via Bluetooth. The sprayer is ideal for large emulsion projects, such as new builds or renovations. The spray pack is optimized for use with emulsion and latex paints. ProSpray product features such as robust packings, inlet valve pusher, brushless motor, tipping car, automatic oiling and the DigiTrac Control digital display guarantee low-maintenance operation and ease of use.



Tiltable cart: for a quick container change.

IntelliSync unit: Establishes a Bluetooth connection between the sprayer and the SprayManager app

Large high-pressure filter: prevents paint clogging, is easily accessible and easy to clean

Airless gun Vector Grip: light, durable and particularly ergonomic

Automatic oiling: simply press a button to oil pistons and protect packings

Digi-Trac-Control System: processes machine data, consumption values, running times and much more digitally. Intelligent deadband control, slow motion function and frequency clean for trouble-free operation and fast cleaning

SCOPE OF DELIVERY

Base unit ProSpray 3.31 Connect	-
HP hose DN6	9984574
Airless Vector Grip gun, incl. TradeTip 3 nozzle holder	0538043
HEA ProTip 521	554521
PROSPRAY 3.31 CONNECT SPRAYPACK	2420184

TECHNICAL DATA

Voltage	230 V / 50 Hz
Motor output	1.84 kW
Operating pressure, max.	221 bar, 22.1 MPa
Delivery rate, max.	3.8 l/min
Nozzle size, max.	0.032"
Recommended hose length, max.	60 m
Viscosity, max.	25.000 mPas
Weight	43.5 kg

PROSPRAY 3.39 EMULSION

The reliable choice for large-scale emulsion work

The most powerful electric WAGNER airless piston pump from the ProSpray family processes virtually all materials on large construction sites, from paints and varnishes to interior and exterior emulsions, latex paints and airless spray fillers. The emulsion spray pack of the ProSpray 3.39 is even suitable for use with two spray guns, allowing large construction sites to be handled efficiently. This is made possible by the low-lying intake valve, which improves the intake performance.



Spray an outstanding surface quality:

The Vector Grip airless gun is light in weight and has a long service life



Overview with Digi-Trac Control:

The digital display shows machine data, consumption values, run times and much more. Intelligent deadband control, SlowMotion function and Frequency-Clean guarantee trouble-free operation and fast cleaning

Low maintenance costs: Self-adjusting packings lead to less wear and are easy to change. They have a service life up to 50 % longer compared to regular packings

No nozzle blockages: The high-pressure filter is easily accessible and quick to clean. Three different filter inserts (fine, medium, coarse) ensure an optimal match with the material

Tiltable trolley: for a quick container change. Site-specific tyres enable convenient transport

Maintenance-free, brushless DC motor: It works very efficiently at both low and high speeds. Continuous paint pressure measurement automatically controls the motor speed and ensures constant material pressure



SCOPE OF DELIVERY

Base unit ProSpray 3.39	-
HP hose DN6	9984574
Airless gun Vector Grip, incl. TradeTip 3 nozzle holder	0538043
HEA ProTip nozzle 519	554519
PROSPRAY 3.39 EMULSION SPRAYPACK	2351261

TECHNICAL DATA

Voltage	230 V / 50 Hz
Motor output	2.19 kW
Operating pressure, max.	221 bar, 22.1 MPa
Delivery rate, max.	5 l/min
Nozzle size, max.	0.039"
Recommended hose length, max.	60 m
Viscosity, max.	30.000 mPas
Weight	50 kg

PROSPRAY 3.39 FILLER

Leistungsstarker Spezialist für Airless-Spritzspachtel

The low-lying intake valve makes the ProSpray 3.39 the most powerful WAGNER Airless piston pump in the ProSpray family. On large construction sites, the ProSpray 3.39 processes many materials such as water and solvent-based lacquers and enamel paints, two-component coating materials, emulsions, latex paints, release agents, oils, undercoats, primers, and fillers. The ProSpray 3.39's plaster spray pack is the perfect entry-level device for plastering work.



Superb spray surface quality: with the Vector Grip Airless gun. Light in weight with a long service life

No nozzle blockages: the high pressure filter is easily accessible and quick to clean. Three different filter inserts (fine, medium, coarse) ensure an optimal match with the material

Tilting cart: fast change of the container. Site-optimized tires allow convenient pump transport

Clearly arranged - DESC-Control: with the digital display you can read out and handle machine data, consumption figures, runtimes and much more. The intelligent deadband control, SlowMotion function and FrequentClean guarantee trouble-free work and quick cleaning

Maintenance-free, brushless direct current motor: due to the improved performance, the motor works even more efficiently at low and also at high speeds. The continuous paint pressure measurement controls the motor speed automatically, thus ensuring a constant material pressure

Low maintenance costs: the practical, self-adjusting packings lead to less wear and are easy to change. They have a service life up to 50% longer than comparable packings



SCOPE OF DELIVERY

Base unit ProSpray 3.39	-
HP hose DN13	2336585
HP hose DN10	2336582
Double connector 3/8" x 1/2"	814-005
Airless gun AG 19 incl. TradeTip 3 nozzle holder	2341127
TradeTip 3 Nozzle 539	553539

PROSPRAY 3.39 CONNECT SPRAYPACK 2308264

TECHNICAL DATA

Voltage	230 V / 50 Hz
Motor output	2.19 kW
Operating pressure, max.	221 bar, 22.1 MPa
Delivery rate, max.	5 l/min
Nozzle size, max.	0.039"
Recommended hose length, max.	60 m
Viscosity, max.	30.000 mPas
Weight	50 kg

PROSPRAY 3.39 EMULSION CONNECT

Powerful piston pump for large construction sites with connective operating concept

WAGNER's most powerful electric airless piston pump from the ProSpray family can process almost any material on large construction sites. For particularly easy operation, the airless device is equipped with IntelliSync and enables a Bluetooth connection to the SprayManager app. The emulsion spray pack is even suitable for operation with two spray guns, so that large construction sites can be processed particularly efficiently.



Large high-pressure filter: prevents paint blockages, is easily accessible and easy to clean

Digi-Trac-Control System: processes machine data, consumption values, running times and much more digitally. Intelligent deadband control, slow motion function and frequency clean for trouble-free operation and fast cleaning

Brushless motor: maintenance-free and reliable



HEA nozzle: For a uniform spray pattern with little spray mist, even in low pressure ranges

Airless gun Vector Grip: lightweight, durable and particularly ergonomic

Rigid suction system: smooth operation directly from the original container

Quick paint change: simple service and shorter response times

SCOPE OF DELIVERY

Base unit ProSpray 3.39 Connect	-
HP hose DN6	9984574
Airless gun Vector Grip, incl. TradeTip 3 nozzle holder	0538043
HEA ProTip nozzle 521	554521
PROSPRAY 3.39 SPRAYPACK	2431358

TECHNICAL DATA

Voltage	230 V / 50 Hz
Motor output	2.19 kW
Operating pressure, max.	221 bar, 22.1 MPa
Delivery rate, max.	5 l/min
Nozzle size, max.	0.039"
Recommended hose length, max.	60 m
Viscosity, max.	30.000 mPas
Weight	50 kg

PROSPRAY 3.39 SPATULA CONNECT

Powerful piston pump for large construction sites with connective operating concept

For particularly easy operation, the airless device is equipped with IntelliSync and enables a Bluetooth connection to the SprayManager app. This allows the device to be controlled and managed via a smart-phone. Other innovative ProSpray product features include the quick-change paint switch, digital display, automatic lubrication, brushless motor, large high-pressure filter and much more.



Automatic oiling: simply press a button to oil pistons and protect packings

Tilttable trolley: for a quick container change

Digi-Trac-Control System: processes machine data, consumption values, running times and much more digitally. Intelligent deadband control, slow motion function and frequency clean for trouble-free operation and fast cleaning

Low-lying suction valve: for extra high suction capacity

TradeTip 3 standard nozzle: reliable and robust reversible nozzle for a good spray pattern

Airless gun AG 19: with extra wide angle for ergonomic working with high-viscosity materials and large hose cross-sections

Inlet valve pusher: for high operational reliability, simply push the valve free



SCOPE OF DELIVERY

Base unit ProSpray 3.39 Connect	-
HP hose DN13	2336585
HP hose DN10	2336582
Double connector 3/8" x 1/2"	814-005
Airless gun AG 19 incl. TradeTip 3 nozzle holder	2341127
TradeTip 3 Nozzle 539	553539

PROSPRAY 3.39 CONNECT SPRAYPACK 2420185

TECHNICAL DATA

Voltage	230 V / 50 Hz
Motor output	2.19 kW
Operating pressure, max.	221 bar, 22.1 MPa
Delivery rate, max.	5 l/min
Nozzle size, max.	0.039"
Recommended hose length, max.	60 m
Viscosity, max.	30.000 mPas
Weight	50 kg

PRACTICAL ACCESSORIES FOR ELECTRIC PISTON PUMPS



HR45 hose reel with hose suitable for all diaphragm and piston pumps

HOSE REEL

Art. No.

HR45 hose reel, incl. 30 m HP hose DN6, suitable for all diaphragm and piston pumps

341912



2GUN KIT

FOR CONNECTING UP TO 3 GUNS TO ONE DEVICE
(SF33, PS 3.31 upwards and HeavyCoat pumps)

2413598

Distributor adapter (for max. three guns)

Vector grip gun

HP hose DN6

Double connector NPSM 1/4"

HOPPER

Art. No.

Hopper, 5 liters, for PowerPainter 90 Extra

2423122

Hopper, 5 liters,
for ProSpray 3.20, 20, 3.21, 3.25 frame

704-453



Ideal for processing small quantities of paint or frequent material changes

NOTES

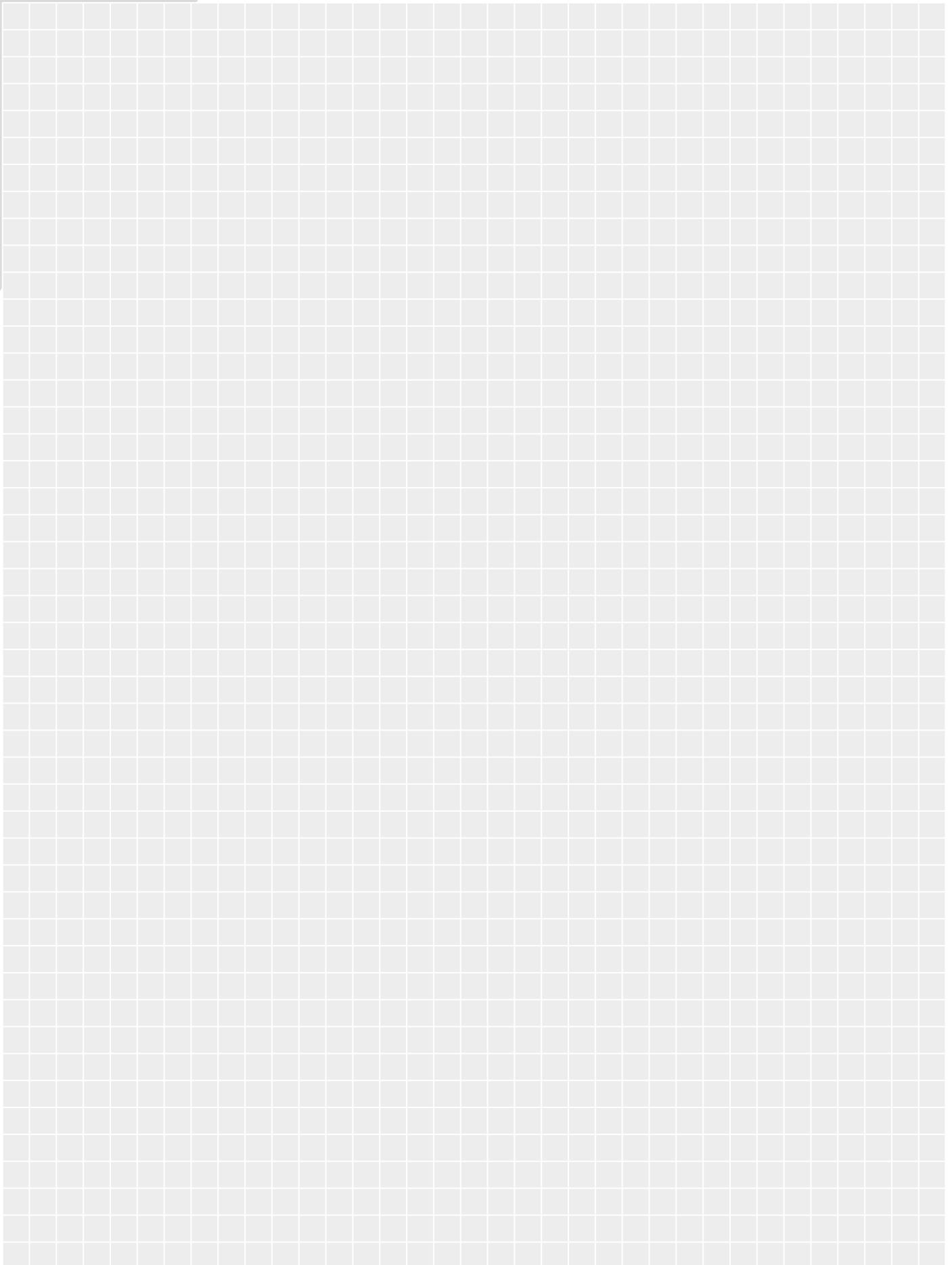

HYDRAULIC PISTON PUMP

Even more power for suction and delivery – with denser materials

Do you mostly work with particularly high-viscosity or very dense materials? Then a WAGNER piston pump is the perfect, reliable site companion for you. The exceptionally high suction and transport power is produced by the piston's stroke movement. This is amplified even further by the hydraulic drive and is particularly ideal for this type of material.



Various performance classes for every professional:

the especially reliable hydraulic pump technology from WAGNER is most suited to large construction sites, with a broad spectrum of applications from building protection and emulsion through to especially high-viscosity and very dense materials for use inside and out.

A powerful companion - inside and out:

WAGNER piston pumps are available with three different drive systems. Electric piston pumps cover a wide range of performance classes and have a compact design. The hydraulic piston pumps offer even better performance and are available with a choice of either a petrol or an electric motor which can be switched in a few minutes. Pneumatically driven piston pumps from WAGNER are explosion-proof and therefore are suitable for use in workshops.

1. WITH EVEN MORE POWER ON THE CONSTRUCTION SITE:

The patented SSP (Special Spray Power) system from WAGNER is a technology that is unique on the market for the application of high viscosity materials. The special design of the system ensures that the pump is continually filled with sufficient material by the shovel piston. SSP is available for all HeavyCoat models.

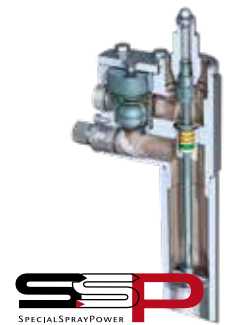

Additional power "Special-Spray-Power" for high viscosity materials

2. NO CONTINUOUS RUNNING:

Piston pumps only operate when you have to build up pressure. The rest of the time, the drive is on 'standby'. This protects wear parts and has a positive impact on site noise levels.

CROSS-SECTION OF THE PISTON

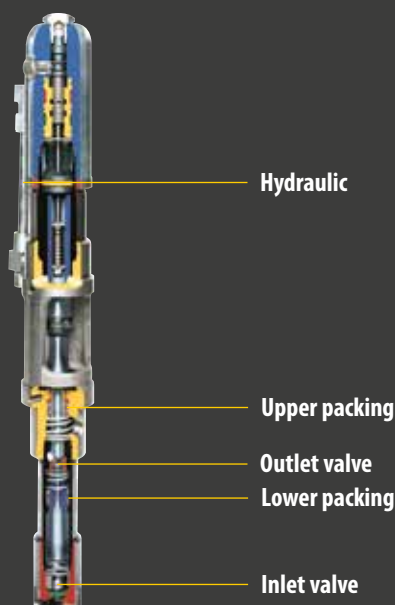

ADVANTAGES

- Better delivery capacity with extreme high viscosity materials
- Less sensitive to heavily filled materials
- High material pressure / material volume allow long hose lengths
- Large nozzle sizes can be used
- Extra-durable packing
- Powerful suction
- Convertible to SSP for additional power

HEAVYCOAT 750

Compact power pack for heavy material

HeavyCoat 750 E is the high-performance airless spray gun from WAGNER. The piston pump impresses with its constant performance when applying heavy materials such as flame retardants, corrosion protection, fabric adhesives, airless spray fillers and building sealants over large areas. The powerful device with a delivery rate of up to 6 l/min is indispensable, especially for large-scale projects such as civil engineering, bridges, sewage treatment plants or flat roofs.



Hydrastroke technology: the operating temperature is reduced by up to 14 °C in comparison to previous hydraulic systems

Ease of maintenance: pump and motor are easily accessible and the lower pump can be removed by loosening just 4 screws. This makes the HC 750 particularly maintenance friendly

Ideal cooling: the robust design of the housing cover with integrated ventilation slots conducts air over all device components that convey hydraulic fluid

Low valve or optionally selectable SSP shovel piston: enable processing of extremely high-viscosity materials

High pressure filter: for high reliability and minimal downtime

Quality spraying: with the high-performance gun AG 14. When used in combination with the 2SpeedTip nozzle for fillers, it is possible to handle even high-viscosity material without difficulty

Available as an electrically driven or petrol-driven model: the basic model without SSP is also available with a petrol motor. This means that it can also be used on construction sites without an electrical connection

Large pneumatic tires: mean that the unit is easy and comfortable to transport, even on difficult terrain



SCOPE OF DELIVERY

Base unit HeavyCoat 750 E/G	-
HP hose DN13	2336585
Hose whip DN10	2336582
Connector 3/8" x 1/2"e	814-005
Airless gun AG 14 incl. TradeTip 3 nozzle holder	0502081A
TradeTip 3 Nozzle 539	553539
HEAVYCOAT 750 E SPRAYPACK	2371027
HEAVYCOAT 750 E SSP SPRAYPACK	2371028
Scope of delivery as above, (gun replaced with):	
Airless gun AG 19 incl. TradeTip 3 nozzle holder	2341127
HEAVYCOAT 750 G SPRAYPACK	2371029
Scope of delivery as above, plus	
Coupling sleeve I = 1/4" NPSM x A = 3/8" NPSM (not for SSP)	179732

TECHNICAL DATA

	HEAVYCOAT 750 E / SSP	HEAVYCOAT 750 G
Voltage	230 V / 50 Hz	-
Motor output	3.1 kW	4.1 kW
Operating pressure, max.	250 bar, 25 MPa	250 bar, 25 MPa
Delivery rate, max.	6 l/min	7.6 l/min
Nozzle size, max.	0.043"	0.041"
Recommended max. hose length	100 m	100 m
Viscosity, max.	50.000 mPas	65.000 mPas
Weight	85 kg / 87 kg	81 kg

HEAVYCOAT 950

Power pack for the heaviest material

The WAGNER HeavyCoat 950 E piston pump is a very powerful hydraulic airless sprayer and is particularly suitable for large commercial projects where materials such as flame retardant, emulsion, latex, fabric adhesive, corrosion protection, thick-film materials, bitumen or airless spray filler are applied. The WAGNER spray gun is supplied as a ready-to-use spray pack with the high-quality AG 14 airless gun and the practical 2SpeedTip nozzle.



Quality spraying: with the professional gun AG 14 and the TradeTip 3 nozzle for filler, high-viscosity materials can be processed without any problems

Swing-Cart: makes it possible to swing up the pump. Practical when working from a bucket or a container but also for transport

Tidied up: with the integral support hoses up to a length of 60 m can be practically stowed away

In a single action: the unit can be safely depressurized and quickly cleaned

Convenience: the adjustable height telescopic handle makes for convenient transport on the building site or in the in a vehicle

HeavyCoat special hose: with a 3/8", 1/2" or 3/4" cross section for a better spraying performance

High pressure filter: for high reliability and minimal downtime

You have the choice: with or without SSP shovel piston for processing of very high-viscosity materials



SCOPE OF DELIVERY

Base unit HeavyCoat 950 E/G	-
HP hose DN10	2336583
Hose whip DN10 (950 E only)	2336582
Coupling sleeve I = 1/4" NPSM x A = 3/8" NPSM (not 950 E SSP)	179732
Airless gun AG 14 incl. TradeTip 3 nozzle holder	0502081A
TradeTip 3 Nozzle 443	553443

HEAVYCOAT 950 E SPRAYPACK **2332184**

HEAVYCOAT 950 E SSP SPRAYPACK **2332187**

Scope of delivery as above, additionally (gun exchanged with):

HP hose DN13 (950 E SSP)	2336585
Connector 3/8" x 1/2" (950 E SSP)	814-005
Airless gun AG 19 incl. TradeTip 3 nozzle holder (950 E SSP)	2341127

HEAVYCOAT 950 G SPRAYPACK **2332186**

TECHNICAL DATA

	HEAVYCOAT 950 E / SSP	HEAVYCOAT 950 G
Voltage	230 V / 50 Hz	-
Motor output	3.6 kW	4.1 kW
Operating pressure, max.	250 bar, 25 MPa	250 bar, 25 MPa
Delivery rate, max.	6.6 l/min	8 l/min
Nozzle size, max.	0.052"	0.041"
Recommended max. hose length	100 m	100 m
Viscosity, max.	50.000 mPas	65.000 mPas
Weight	83 kg / 84.5 kg	76 kg

HEAVYCOAT 970

All-round Xtra speed for XL projects

The WAGNER HeavyCoat 970 E piston pump is the most powerful pump in the WAGNER range and is operated hydraulically. The airless sprayer is suitable for large commercial projects where materials such as flame retardant, emulsion, latex, fabric adhesive, corrosion protection, thick-film materials, bitumen or airless spray filler are applied. The WAGNER spray gun is supplied as a ready-to-use spray pack with the high-quality AG 19 airless gun and the practical 2SpeedTip trowel nozzle.



Quality spraying: with the professional gun AG 14 and the TradeTip 3 nozzle for filler, high-viscosity materials can be processed without any problems

Swing-Cart: makes it possible to swing up the pump. Practical when working from a bucket or a container but also for transport.

Tied up: with the integral support hoses up to a length of 60 m can be practically stowed away.

With a choice of electric drive or independent of mains electricity with the Honda petrol engine: the units can be converted from electric to petrol drive (or vice versa). This makes them able to be used on building sites with no power supply. Both motors are extremely reliable and longlasting



Convenience: the adjustable height telescopic handle makes for convenient transport on the building site or in the in a vehicle

Construction-site-optimized tires: avoid punctures and allow easy and convenient transport – even on difficult sites

SCOPE OF DELIVERY

Base unit HeavyCoat 970 E/G	-
HP hose DN13	2336585
Hose whip DN10	2336582
Connector 3/8" x 1/2"	814-005
Coupling sleeve I = 1/4 "NPSM x A = 3/8 "NPSM (970 G & E)	179732
Airless gun AG 14 incl. TradeTip 3 nozzle holder (970 G & E)	0502081A
TradeTip 3 Nozzle 443	553443

HEAVYCOAT 970 E SPRAYPACK 2332191

HEAVYCOAT 970 E SSP SPRAYPACK 2332193

Scope of delivery as above, (gun replaced with):

Airless gun AG 19 incl. TradeTip 3 nozzle holder (only with SSP) 2341127

HEAVYCOAT 970 G SPRAYPACK 2332192

HEAVYCOAT 970 G SSP SPRAYPACK 2332194

Scope of delivery as above, (gun replaced with):

Airless gun AG 19 incl. TradeTip 3 nozzle holder (only with SSP) 2341127



TECHNICAL DATA	HEAVYCOAT 970 E / SSP	HEAVYCOAT 970 G / SSP
Voltage	400 V / 50 Hz	-
Motor output	5.5 kW	6 kW
Operating pressure, max.	250 bar, 25 MPa	250 bar, 25 MPa
Delivery rate, max.	10.3 l/min	12 l/min
Nozzle size, max.	0.056"	0.056"
Recommended max. hose length	100 m	100 m
Viscosity, max.	65.000 mPas	65.000 mPas
Weight	100 kg / 103 kg	88 kg

PRACTICAL ACCESSORIES FOR HYDRAULIC PISTON PUMPS

SUCTION SYSTEMS

Art. No.

Container suction system, incl. C-coupling adapter	349907
Reducing adapter B to C coupling	9991651
Blanking plug for C-coupling	97305
Container Connector, for HeavyCoat, for direct suction of the material out of the large volume container	2383128
Large volume container (100 liters)	2309956
Large volume , incl. sack support and roller press	2309960
Sack support with roller guide, for large volume containers	2323178
Suction system	349907



Large volume container with Container Connector - For continuous work



SPRAYKITS



EMULSION KIT (DN6)

FOR ALL PUMPS WITH 1/2" CONNECTIONS
(PS 3.39 AND HEAVYCOAT PUMPS)

2406208

Transition fitting (F) NPSM 1/2" to (M) NPMS 1/4"

2x HP hose DN6

Double connector 1/4" NPSM

Vector Grip gun

Nozzle extension, G-thread, 12.5 cm

Nozzle extension, G-thread, 25 cm

HEA ProTip nozzle 519

TradeTip 3 Nozzle 427

TipClean 200 ml

2x adjustable wrench, 250 mm

Gun filter, white, medium, 10 pieces

Incl. matching adapter and 2x rolling fork spanners



FILLER KIT (DN10)

FOR ALL PUMPS WITH 1/2" CONNECTIONS
(PS 3.39 and HeavyCoat pumps)

2406209

Transition fitting (F) NPSM 1/2" to (M) NPMS 3/8"

HP hose DN10

Double connector 3/8" NPSM to 1/4" NPSM

Airless gun AG 14, G-thread 1/4"

Nozzle extension, G-thread, 25 cm

TradeTip 3 Nozzle 335

TradeTip 3 Nozzle 439

TipClean 200 ml

2x adjustable wrench, 250 mm

Gun filter, white, medium, 10 pieces



2GUN KIT

FOR CONNECTING UP TO 3 GUNS TO ONE DEVICE
(SF33, PS 3.31 upwards and HeavyCoat pumps)

2413598

Distributor adapter (for max. three guns)

Vector grip gun

HP hose DN6

Double connector NPSM 1/4"



SPIRAL PUMP

Simple operation – powerful and versatile

Do you appreciate the machine-based application of material, especially for harder tasks? Then a spiral pump from WAGNER is exactly the strong power packet you need for your construction sites. The robust, powerful performance of a spiral pump is delivered by a really simple rotor-stator function that WAGNER has been successfully using on the market for decades.



Robust, faithful reliable power packet for those difficult tasks:

Spiral pumps, also called eccentric spiral pumps, use displacement mechanisms to deliver the material. Two components, the rotor and the stator, are used for this. The rotor rotates and in doing so transports the material gently through the cavities of the stator. This simple function enables extremely heavy materials with different granulation and even fibres, such as render and other materials containing fillers, to be processed extremely efficiently.

The solution for heavy, textured material:

WAGNER spiral pumps can be used to achieve high-quality surfaces at a high working speed, for example with machine-assisted plaster application. Here the heavy, highly viscous material is moved with the help of the spiral pump through the hose to the spray gun, where it is atomized and applied smoothly. Comfortable and controlled, just like you're used to with WAGNER airless spray devices.

1. EASY TO OPERATE:

The simple, user-friendly operating concept for controlling the rotor and stator guarantees problem-free use, even for beginners.

2. FAST CLEANING:

WAGNER spiral pumps can be quickly disassembled for cleaning and maintenance and reassembled again thanks to the simple stator design, including directly on the construction site. This is made especially easy on the WAGNER PlastCoat 1030 by the automatic stator withdrawal. The material-carrying parts are also made from special materials which are easy to clean.

3. LONG SERVICE LIFE:

WAGNER spiral pumps are robust and easy to use. They are especially low-wear and low-maintenance, and are considerably quieter in operation than conventional piston pumps.

CROSS-SECTION OF THE SPIRAL PUMP

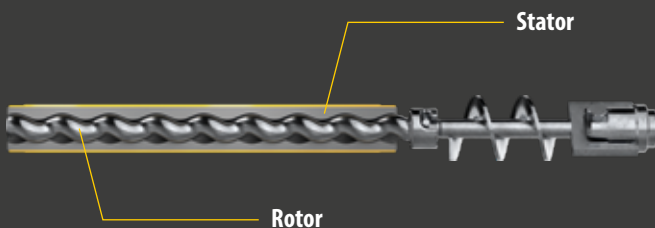

ADVANTAGES

- Simple and sturdy technology
- Gentle material transport
- Powerful processing of highly viscous materials
- Fully adjustable control of spray pressure
- Long lifespan
- Low maintenance

PLASTCOAT HP 30

Uniting the best – robust high-pressure spiral pump with airless technology for high-viscosity fillers

The PlastCoat HP 30 high-pressure screw pump from WAGNER impresses with its simple operation, reliability and high performance. This is made possible by the combination of robust rotor-stator pump technology with convenient airless technology. The versatile screw pump is suitable for everything from water-based primers to fabric adhesives and high-viscosity putties. PlastCoat HP 30 is supplied as a spray pack with the AG 19 airless gun.



High-performance guns:

with the airless gun AG 19, even high-viscosity materials can be processed without any problems



Colour-coded pressure gauge: allows perfect control of the pressure in coordination with the material being processed

HEA HIGH EFFICIENCY AIRLESS

Einfach umrüstbar für Emulsionsarbeiten: Mit dem Emulsions Kit.

Plastic material hopper: easy to clean and with a capacity of 50 liters. Cover for the material hopper available separately as an accessory (Art. No. 2400 030)

Compact dimensions: with a height of 62 cm, the device can easily be filled with material



Easy control: thanks to the user friendly control panel

Perfect for every construction site: the large, pneumatic tires ensure mobility on any construction site

Quiet and comfortable Airless spraying: without additional compressor with up to 120 bar working pressure

PlastCoat HP 30 with optionally available emulsion kit.



SCOPE OF DELIVERY SPRAYPACK SPACHTEL

Base unit PC HP 30	-
HD hose DN19	2390763
HD hose whip DN10	2390762
Airless gun AG 19, incl. TradeTip 3 nozzle holder	2341127
TradeTip 3 nozzle 443	553443
PlastGuard longlasting pump protector	2399960

PLASTCOAT HP 30 SPATULA SPRAYPACK 2388301

ACCESSORIES FOR EMULSION WORK

HD Hose DN10	2336583
Airless Vector Pro gun incl. TradeTip 3 nozzle holder	538045
HEA ProTip nozzle 517	554517
Adapter FM 1/2BSPP-3/8NPSM	2332623
Adapter FM 1/4 NPSM-3/8NPSM	179732

PLASTCOAT HP 30 DISPERSIONS KIT 2400684

TECHNICAL DATA

Voltage	230 V / 50 Hz
Motor output	2.3 kW
Operating pressure, max.	120 bar, 12 MPa
Delivery rate, max.	> 10 l/min
Nozzle size, max.	0.055"
Recommended hose length, max.	22.5 m
Weight	72 kg

PLASTCOAT 1030 E

The power to handle large volumes – compact and versatile

With the WAGNER PlastCoat 1030 worm pump, all plaster application tasks can be carried out efficiently: Plastering (fine and decorative plaster, plaster primer), coating (aerated concrete coating, levelling compounds), bonding/reinforcing (interior plaster, bonding, reinforcing and tiling mortar), filling and grouting (wall, joint and frame grouting mortar) and filling (insulating and levelling compounds).



Compact dimensions: with a height of 62 cm the unit can be easily filled using buckets or combined with a flow mixer

Plastic materialhopper: for an easy cleaning with a capacity of up to 50 liter

Automatic stator extraction: fast separation of pump and suction system, also great for quick assembly. Ideal for easy cleaning and transport



Included in scope of delivery: PC 1030 comes complete ready to spray incl. mortar hose (DN25, 10 m), automatic spraying lance with nozzle and toolbox.

Perfectly equipped for all construction sites: big, pneumatic tires ensures mobility on all construction sites

Ergonomic spraying lance: due to its modular construction and accessories (e.g. the lance extension) the spraying lance can adapt quickly to any project

SCOPE OF DELIVERY

Base unit PlastCoat 1030 E	-
Mortar hose DN25 incl. air hose and control cable	2325197
Spraying lance automatic incl. 6 mm nozzle	2334115
Pump lubricant, 500 ml	9992824

PLASTCOAT 1030 E SPRAYPACK **2361588**

TECHNICAL DATA

Voltage	230 V / 50 Hz
Motor output	2.2 kW
Operating pressure, max.	40 bar, 4 MPa
Delivery rate, max.	15 l/min
Grain size, max.	6mm
Recommended hose length, max.	40 m
Weight	59 kg

PRACTICAL ACCESS HP 30

HOSES	Art. No.
HD hose DN19, 10 m	2390763
HD hose whip, DN10, 2.5 m	2390762
HP hose DN10, max. 25 MPa, NPSM 3/8", 15 m	2336583

SPRAY GUNS AND NOZZLES	Art. No.
Airless gun AG 19, 25 MPa, G-thread 3/8", incl. TradeTip 3 nozzle holder	2341127
Airless gun Vector Pro, 1/4", incl. TradeTip3 nozzle holder, with 4-finger trigger	538040
TradeTip 3 nozzles	553xxx
HEA ProTip nozzles	554xxx
Nozzle holder, G-thread 7/8", for TradeTip 3 nozzles	289390

OTHER	Art. No.
Nozzle extension, with holder without nozzle, 25 cm	2418854
Nozzle extension, with holder without nozzle, 50 cm	2418855
Cleaning ball DN16	2402355
Cleaning ball DN19	342330
Rotor and stator, complete, for PlastCoat HP 30	2395996
Cover for material container	2400030
Press table	2389048
PlastGuard longlasting pump protector, 5 liters	2399960

PRACTICAL ACCESS PC 1030

MORTAR HOSES, INCL. AIR HOSE AND CONTROL CABLE	Art. No.
Mortar hose DN19, V/M 27, 2 m incl. swivel joint	2334131
Mortar hose DN19, V/M 27, 10 m	2325193
Mortar hose DN25, V/M 27, 10 m	2325197
Mortar hose DN35, V/M 35, 13.3 m	2325199

NOZZLES	Art. No.
Structural nozzle, stainless steel, 4 mm	268779
Structural nozzle, stainless steel, 6 mm	268780
Structural nozzle, stainless steel, 8 mm	268781
Structural nozzle, stainless steel, 10 mm	268782
Structural nozzle, stainless steel, 12 mm	342327
Structural nozzle, stainless steel, 15 mm	342328

ROTOR-STATOR KITS	Art. No.
Rotor, D 6 - Delivery rate max: 2.5, 7.5 l/min	348312
Stator, D 6 - max. flow rate: 2.5, 7.5 l/min, black	348311
Rotor, D 6 - max. flow rate: 3, 10 l/min	348316
Stator, D 6 - max. flow rate: 3, 10 l/min, yellow	348315
Rotor, D 7 - max. flow rate: 2, 15 l/min	348926
Stator, D 7 - max. flow rate: 2, 15 l/min, brown	348925
Rotor, D 8 - max. flow rate: 1.5, 20 l/min	2385520
Stator, D 8 - max. flow rate: 1.5, 20 l/min, green	2385532



PRESS-OUT TABLE

Our practical helper for the quick processing of bagged goods is available separately as an accessory (Art. No. 2389048).

TEMPSPRAY AIRLESS HEATED HOSE

Optimized for spraying highly viscous materials without dilution

Would you always like to ensure the ideal processing temperature and best viscosity of the material you are spraying, regardless of any seasonal fluctuations in temperature? The Temp-Spray heated hose from WAGNER is your guarantee for the best possible surface quality. The electric heating element, located directly in the flow of paint inside the hose system, heats the material evenly over the entire length of the hose to the pre-set temperature.



Heat up instead of diluting:

The ideal viscosity, along with the right working technique and equipment, are crucial for impressive results when spraying. If material is too thick, the result is an irregular spray pattern and a poor paint application. To make coating materials sprayable they usually have to be diluted. Heating the material with a TempSpray heated hose system from WAGNER has the same effect: viscosity is reduced, improving the application of the material. The result is a soft spray pattern and optimized atomization quality.

Perfectly equipped for every area of application:

Heating the material in the heated hose improves the spraying properties of numerous coating materials - from stains and lacquers through to adhesives. The TempSpray systems can be fully controlled from 20° to 60°C. They can be used with all WAGNER airless devices, offering a broad range of applications.

1. LESS SOLVENT, VOC-COMPLIANT:

Heating the material reduces the amount of solvent needed since the material no longer needs to be diluted to achieve the required spray viscosity.

2. LOWER SPRAY PRESSURE:

Heating reduces the material's viscosity, allowing a lower spray pressure to be used. This reduces the overspray, protects the device being used and also protects the operator.

CHANGE IN VISCOSITY

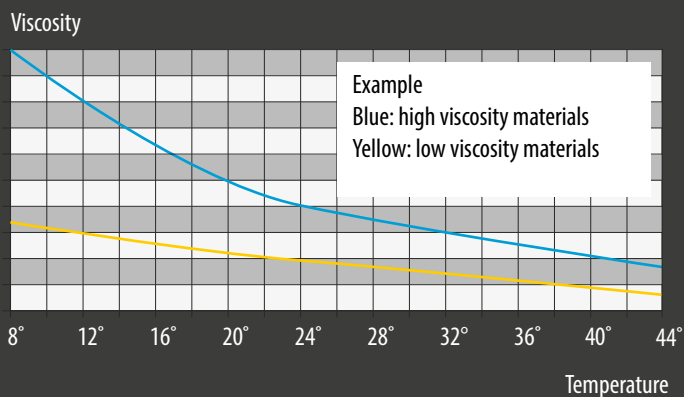

ADVANTAGES

- Easy to use
- Reduction of overspray
- Paint savings thanks to less overspray
- Increase in the thickness of the layers applied
- Less wear and tear on the device
- Constant paint temperature, even when outdoor temperatures are low
- Excellent edge coverage

TEMPSPRAY H 126

The system that simplifies your work – perfect surface finishes through reduced viscosity with material heating

The WAGNER TempSpray H 126 Spraypack is ideal for airless paint application and is equipped with a lightweight and flexible 10 m DN6 stainless steel hose and the ergonomic Vector Grip airless gun. This makes the 3.5 kg TempSpray device the ideal accessory for airless diaphragm and piston pumps.



Spray with excellent surface quality: the Vector Grip Airless gun is lightweight and has a long service life

Also available as a base unit for combining with existing Airless guns.
Art. No. 2311659



Also ideal in combination with AirCoat for very fine atomization



Clearly laid-out control unit: the required temperature can be fully adjusted from 20° C to 60° C as needed by pressing the arrow buttons.

Perfect surface finish with TempSpray: heating of the coating material produces a soft spray pattern and therefore perfect atomization. Other advantages include less overspray, perfect viscosity without dilution and much more.

Compact unit: thanks to integrated heating element

Flexible and robust: 10 m long DN6 stainless steel hose

TECHNICAL DATA

Voltage	230 V / 50 Hz
Motor output	0.6 kW
Operating pressure, max.	250 bar, 25 MPa
Temperature controller	20 - 60 °C
Hose length	10 m
Viscosity, max.	5.000 mPas
Mains connection cable	4 m

SCOPE OF DELIVERY

Base unit TempSpray H 126, 10 m	2311659
Airless Vector Grip gun incl. TradeTip 3 nozzle holder	538043
TradeTip 3 FineFinish nozzle 410	554410

TEMPSPRAY H 126 SPRAYPACK 2311852

TEMPSPRAY H 226

Practical material heating system – for emulsions and latex paints

Are you a painter or decorator, do you own an airless sprayer and do you value perfect surface coatings of emulsion latex paints? Then the TempSpray H 226 Spraypack with its site-specific hose reel on cart is the perfect accessory for your airless device. The heated hose system allows the material to be heated continuously from 20° to 60° C as required. This means you always work in the best conditions, regardless of seasonal fluctuations.



Spray with excellent surface quality: the Airless Gun AG 14 is robust and has a long service life

Mobile: thanks to construction site-compatible reel drum

Clearly laid-out control unit: the required temperature can be fully adjusted from 20°C to 60°C as needed by pressing the arrow buttons

Also available as a base unit for combining with existing Airless guns
Art. No. 2311660



Perfect surface finish with Temp-Spray: heating of the coating material produces a soft spray pattern and therefore perfect atomization. Other advantages include less overspray, perfect viscosity without dilution and much more

SCOPE OF DELIVERY

Base unit TempSpray H 226, 15 m	2311660
Airless gun AG 14 incl. TradeTip 3 nozzle holder	0502081A
HEA ProTip nozzle 517	554517
TEMPSPRAY H 226 SPRAYPACK	2311853

TECHNICAL DATA

Voltage	230 V / 50 Hz
Heating power	1.3 kW
Operating pressure, max.	250 bar, 25 MPa
Temperature controller	20 - 60 °C
Hose length	15 m
Viscosity, max.	25.000 mPas
Mains connection cable	6 m

TEMPSPRAY H 326

The longest TempSpray of all time – for extended versatility and working radius

TempSpray H 326 Spraypack from WAGNER is suitable for the application of emulsions and latex paints and is the perfect accessory for all painters and decorators who already work with airless equipment. The construction site-friendly hose reel on a cart enables easy transportation and is equipped with a 30 m long high-pressure hose, which guarantees a large working radius.



Spray with excellent surface quality: the Airless Gun AG 14 is robust and has a long service life

Mobile: thanks to construction site-compatible hose reel and extra-long hose (30m).

Also available as a base unit for combination with existing airless guns.

Art. No. 2311661



Clearly laid-out control unit: the required temperature can be fully adjusted from 20°C to 60°C as needed by pressing the arrow buttons

Perfect surface finish with TempSpray: heating of the coating material produces a soft spray pattern and therefore perfect atomization. Other advantages include less overspray, perfect viscosity without dilution and much more

TECHNICAL DATA

Voltage	230 V / 50 Hz
Heating power	1.1 kW
Operating pressure, max.	250 bar, 25 MPa
Temperature controller	20 - 60 °C
Hose length	30 m
Viscosity, max.	25.000 mPas
Mains connection cable	6 m

SCOPE OF DELIVERY

Base unit TempSpray H 326, 30 m	2311661
Airless gun AG 14 incl. TradeTip 3 nozzle holder	0502081A
HEA ProTip nozzle 521	554521
TEMPSPRAY H 326 SPRAYPACK	2311854

STEAMER SYSTEMS

Efficient without chemicals

Everyone wants speed and efficiency when it comes to renovation work. Every tradesperson strives to achieve excellent results in a feasible timeframe. Preparations, such as cleaning or pre-treatment of the surface, must usually be carried out before work begins. And of course, the first thing that comes to mind is scraping off the old wallpaper. This tedious and laborious process can become challenging without the right equipment.



Particularly powerful and flexible:

Surfaces that are to be coated must be dry and clean. Often old coatings also have to be removed. The biggest enemy of coatings of any kind, be it paint, latex or powder coating, are residues of cleaning agents, old coatings or the smallest residues of grease and dirt which can cause the new material to peel off. Many companies resort to chemical or physical cleaning methods to ensure surfaces are primed for optimal adhesion. An alternative are electric tools for surface preparation that work on the basis of steam. Multifunctional devices such as those from WAGNER are therefore not only suitable for the residue-free removal of old wallpaper, but also for the thorough cleaning of surfaces and components that must be absolutely grease-free and free of residues of any kind before further treatment. Rely on the power of steam.

IDEAL FOR REMOVING LARGE AREAS OF WALLPAPER:

Suitable for all wallpapers - even coated wallpapers or multiple layers on the wall.

ROBUST PROFESSIONAL TOOL WITH STEP:

hard-to-reach areas can be worked on without a ladder.

DURABLE:

anodised water tank protects against corrosion.

SAFE AND COMFORTABLE:

heat-insulated working hose.

NO PRE-TREATMENT WITH CLEANING AGENTS NECESSARY:

Even small particles can be removed from the surface without leaving any residue thanks to the natural power of steam.



ADVANTAGES

- Sustainable, without chemical additives
- Easy to operate
- Suitable for processing large and small areas
- High working speed
- Simultaneous removal of several layers of wallpaper

STEAMFORCE SPEED PRO

The steam wallpaper stripper for professionals

Quick to use thanks to minimal heat-up time - the innovative Flash Boil technology means the SteamForce Speed Pro steam wallpaper stripper is ready for use in less than 4 minutes. Two practical plate sizes are included: a small one for narrow areas and a larger one for efficiently processing large areas. Thanks to its high performance, several layers of wallpaper can be removed easily and without leaving any residue.



5.1 liter water tank: removable for easy filling

Integrated step: hard-to-reach areas can be worked on without a ladder



Water level indicator: easily see the current fill level

Descaling light: indicates the time for descaling

Flash Boil technology: rapid heating of the water in under four minutes

SCOPE OF DELIVERY

Base unit SteamForce Speed Pro	-
5m hose	2448661
Large steam plate	2448647
Steam plate small	2414573
STEAMFORCE SPEED PRO	2418213

TECHNICAL DATA

Voltage	230 V / 50 Hz
Load capacity step	150 kg
Container volume	5,1 l
Steam time max.	78 min
Power / heat output, max	2750 W
Size of the steam plates	321 x 242 mm and 150 x 75 mm
Mains cable length	5 m
Hose length	5 m
Weight	7.5 kg

	FINISHCONTROL 3500	FINISHCONTROL 4000 18V FINESPRAY	FINISHCONTROL 5500	FINECOAT 9700	FINECOAT 9900 PLUS
Product image (may differ)					
Spraying method					
Technology					
Drive					
Voltage	230 V / 50 Hz	18V	230 V / 50 Hz	230 V / 50 Hz	230 V / 50 Hz
Motot output	0.7 kW	370 W	1.15 kW	1.15 kW	1.5 kW
Operating pressure, max.	0.2 bar, 0.02 MPa	0.2 bar, 0.02 MPa	0.29 bar, 0.029 MPa	0.3 bar, 0.03 MPa	0.72 bar, 0.072MPa
Delivery rate, max.	-	-	-	-	-
Nozzle size, max.	-	-	-	-	-
Recommended hose length, max.	-	-	-	-	-
Viscosity, max.	-	-	-	-	-
Weight	2.3 kg	1.3 kg (excl. battery)	6.6 kg	6.8 kg	15 kg
Art. No.	2341501	Standard spray With battery 2453688 Without battery 2453687 FineSpray With battery 2437240 Without battery 2437348	2422986	2426601	276048
Suitable material					
Suitable material - additional accessories are needed				-	-
Recommended intensity					



Water and solvent-based paints,
lacquers, oils, separating agents



Synthetic resin lacquers,
PVC lacquers, 2K lacquers



Primers, fillers



Fire protection,
rust protection paints



Emulsion and latex paints,
adhesives, sealants



Exterior paints, roof coatings,
floor coatings, textured paint



Structural waterproofing,
bituminous coatings



Filler



Plaster



Injection

	SUPERFINISH 21 PRO HEA	SUPERFINISH 21 PRO AIRLESS ENAMEL	SUPERFINISH 23 PRO HEA	SUPERFINISH 23 PLUS HEA	SUPERFINISH 23 PLUS AIRLESS ENAMEL
Product image (may differ)					
Spraying method					
Technology					
Drive					
Voltage	230 - 240 V AC / 50 Hz	230 - 240 V AC / 50 Hz	230 V / 50 Hz	230 V / 50 Hz	230 V / 50 Hz
Motot output	0.9 kW	0.9 kW	1.3 kW	1.3 kW	1.3 kW
Operating pressure, max.	207 bar, 20.7 MPa	207 bar, 20.7 MPa	250 bar, 25 MPa	250 bar, 25 MPa	250 bar, 25 MPa
Delivery rate, max.	2.1 l/min	2.1 l/min	2.6 l/min	2.6 l/min	2.6 l/min
Nozzle size, max.	0.021"	0.021"	0.023"	0.023"	0.023"
Recommended hose length, max.	15 m	15 m	30 m	30 m	30 m
Viscosity, max.	15.000 mPas	15.000 mPas	20.000 mPas	20.000 mPas	20.000 mPas
Weight	23.6 kg	23.6 kg	27 kg	29 kg	29 kg
Art. No.	2437311	2437312	2399198	2384153	2341492
Suitable material					
Suitable material - additional accessories are needed					
Recommended intensity					

Small objects
up to 50 m²

Residential
50 m² - 200m²

Large residential
200 m² - 800m²

Commercial
more than 800m²

XVLP / HVLP

AirCoat

Airless

Plaster spraying

Piston pump

Diaphragm pump

Turbine



































Spiral pumps

Battery

Electric

Petrol-driven

TempSpray

	SUPERFINISH 23 PLUS TEMPSPRAY	SUPERFINISH 23 PLUS AIRCOAT ENAMEL	SUPERFINISH 23 CR (NO SPRAYPACK)	SUPERFINISH 33 PRO	SUPERFINISH 33 PLUS
Product image (may differ)					
Spraying method			Injection		
Technology					
Drive					
Voltage	230 V / 50 Hz	230 V / 50 Hz	230 V / 50 Hz	230 V / 50 Hz	230 V / 50 Hz
Motot output	1.3 kW	1.3 kW	1.3 kW	2.2 kW	2.2 kW
Operating pressure, max.	250 bar, 25 MPa	250 bar, 25 MPa	250 bar, 25 MPa	250 bar, 25 MPa	250 bar, 25 MPa
Delivery rate, max.	2.6 l/min	2.6 l/min	2.6 l/min	4.3 l/min	4.3 l/min
Nozzle size, max.	0.023"	0.023"	0.023"	0.033"	0.033"
Recommended hose length, max.	10 m	7.5 m	15 m	60 m	60 m
Viscosity, max.	20.000 mPas	20.000 mPas	20.000 mPas	25.000 mPas	25.000 mPas
Weight	29 kg	29 kg	29 kg	43 kg	50 kg
Art. No.	2341496	2353393	2415601	2388260	2388259
Suitable material					
Suitable material - additional accessories are needed					
Recommended intensity					

 Water and solvent-based paints, lacquers, oils, separating agents

 Synthetic resin lacquers, PVC lacquers, 2K lacquers

 Primers, fillers

 Fire protection, rust protection paints

 Emulsion and latex paints, adhesives, sealants



































 Exterior paints, roof coatings, floor coatings, textured paint

 Structural waterproofing, bituminous coatings

 Filler

 Plaster

 Injection

	POWERPAINTER 90 EXTRA - SKID VERSION	POWERPAINTER 90 EXTRA - CART VERSION	PROSPRAY 3.20 HEA	PROSPRAY 3.21 HEA	PROSPRAY 3.25
Product image (may differ)					
Spraying method					
Technology					
Drive					
Voltage	230 V / 50 Hz	230 V / 50 Hz	230 V / 50 Hz	230 V / 50 Hz	230 V / 50 Hz
Motot output	0.8 kW	0.8 kW	1.0 kW	1.035 kW	1.1 kW
Operating pressure, max.	200 bar, 20 MPa	200 bar, 20 MPa	207 bar, 20.7 MPa	221 bar, 22.1 MPa	221 bar, 22.1 MPa
Delivery rate, max.	1.9 l/min	1.9 l/min	2 l/min	2 l/min	2.6 l/min
Nozzle size, max.	0.019"	0.019"	0.021"	0.023"	0.027"
Recommended hose length, max.	15 m	15 m	30 m	30 m	30 m
Viscosity, max.	-	-	20.000 mPas	20.000 mPas	25.000 mPas
Weight	10.2 kg	18 kg	13.6 kg	17.9 kg	27.4 kg
Art. No.	2414079	2401275	2412438	532089	2308260
Suitable material					
Suitable material - additional accessories are needed					
Recommended intensity					

 Small objects
up to 50 m²

 Residential
50 m² - 200m²

 Large residential
200 m² - 800m²

 Commercial
more than 800m²

 XVLP / HVLP

 AirCoat

 Airless

 Plaster spraying

 Piston pump

 Diaphragm pump

 Turbine

 Spiral pumps

 Battery

 Electric

 Petrol-driven

 TempSpray

	PROSPRAY 3.25 CONNECT	PROSPRAY 3.31	PROSPRAY 3.31 CONNECT	PROSPRAY 3.39 EMULSION	PROSPRAY 3.39 FILLER
Product image (may differ)					
Spraying method					
Technology					
Drive					
Voltage	230 V / 50 Hz	230 V / 50 Hz	230 V / 50 Hz	230 V / 50 Hz	230 V / 50 Hz
Motot output	1.1 kW	1.84 kW	1.84 kW	2.19 kW	2.19 kW
Operating pressure, max.	221 bar, 22.1 MPa	221 bar, 22.1 MPa	221 bar, 22.1 MPa	221 bar, 22.1 MPa	221 bar, 22.1 MPa
Delivery rate, max.	2.6 l/min	3.8 l/min	3.8 l/min	5 l/min	5 l/min
Nozzle size, max.	0.027"	0.032"	0.032"	0.039"	0.039"
Grain size, max.	-	-	-	-	-
Recommended hose length, max.	30 m	60 m	60 m	60 m	60 m
Viscosity, max.	25.000 mPas	25.000 mPas	25.000 mPas	30.000 mPas	30.000 mPas
Weight	27.4 kg	43.5 kg	43.5 kg	50 kg	50 kg
Art. No.	2420182	2308262	2420184	2351261	2308264
Suitable material					
Suitable material - additional accessories are needed					
Recommended intensity					

Water and solvent-based paints, lacquers, oils, separating agents

Fire protection, rust protection paints

Structural waterproofing, bituminous coatings

Injection

Synthetic resin lacquers, PVC lacquers, 2K lacquers

































Emulsion and latex paints, adhesives, sealants

Filler

Primers, fillers

Exterior paints, roof coatings, floor coatings, textured paint

Plaster

	PROSPRAY 3.39 EMULSION CONNECT	PROSPRAY 3.39 FILLER CONNECT	HEAVYCOAT 750 E / E SSP	HEAVYCOAT 750 G	HEAVYCOAT 950 E / E SSP
Product image (may differ)					
Spraying method					
Technology					
Drive					
Voltage	230 V / 50 Hz	230 V / 50 Hz	230 V / 50 Hz	230 V / 50 Hz	230 V / 50 Hz
Motot output	2.19 kW	2.19 kW	3.1 kW	4.1 kW	3.6 kW
Operating pressure, max.	221 bar, 22.1 MPa	221 bar, 22.1 MPa	250 bar, 25 MPa	250 bar, 25 MPa	250 bar, 25 MPa
Delivery rate, max.	5 l/min	5 l/min	6 l/min	7.6 l/min	6.6 l/min
Nozzle size, max.	0.039"	0.039"	0.043"	0.041"	0.052"
Grain size, max.	-	-	-	-	-
Recommended hose length, max.	60 m	60 m	100 m	100 m	100 m
Viscosity, max.	30.000 mPas	30.000 mPas	50.000 mPas	65.000 mPas	50.000 mPas
Weight	50 kg	50 kg	85 kg / 87 kg	81 kg	83 kg / 84.5 kg
Art. No.	2431358	2420185	2371027 / 2371028	2371029	2332184 / 2332187
Suitable material					
Suitable material - additional accessories are needed			-	-	-
Recommended intensity					



Small objects
up to 50 m²



Residential
50 m² - 200m²



Large residential
200 m² - 800m²



Commercial
more than 800m²



XVLP / HVLP



AirCoat



Airless



Plaster spraying



Piston pump



Diaphragm pump



Turbine



Spiral pumps



Battery

































Electric





Petrol-driven



TempSpray

	HEAVYCOAT 950 G	HEAVYCOAT 970 E / E SSP	HEAVYCOAT 970 G / G SSP	PLASTCOAT HP 30	PLASTCOAT 1030 E
Product image (may differ)					
Spraying method					
Technology					
Drive					
Voltage	230 V / 50 Hz	400 V / 50 Hz	400 V / 50 Hz	230 V / 50 Hz	230 V / 50 Hz
Motot output	4.1 kW	5.5 kW	6 kW	2.3 kW	2.2 kW
Operating pressure, max.	250 bar, 25 MPa	250 bar, 25 MPa	250 bar, 25 MPa	120 bar, 12 MPa	40 bar, 4 MPa
Delivery rate, max.	8 l/min	10.3 l/min	12 l/min	> 10 kg/min	15 l/min
Nozzle size, max.	0.052"	0.056"	0.056"	0.055"	-
Grain size, max.	-	-	-	-	K6 mm
Recommended hose length, max.	100 m	100 m	100 m	22.5 m	40 m
Viscosity, max.	50.000 mPas	65.000 mPas	65.000 mPas	-	-
Weight	76 kg	100 kg / 103 kg	88 kg	72 kg	59 kg
Art. No.	2332186	2332191 / 2332193	2332192 / 2332194	2388301	2361588
Suitable material					
Suitable material - additional accessories are needed	-	-	-	-	-
Recommended intensity					

 Water and solvent-based paints, lacquers, oils, separating agents

 Fire protection, rust protection paints

 Structural waterproofing, bituminous coatings

 Injection

 Synthetic resin lacquers, PVC lacquers, 2K lacquers















 Emulsion and latex paints, adhesives, sealants

 Filler

 Primers, fillers

 Exterior paints, roof coatings, floor coatings, textured paint

 Plaster

	TEMPSPRAY H 126 BASE UNIT	TEMPSPRAY H 126 SPRAYPACK	TEMPSPRAY H 226 BASE UNIT	TEMPSPRAY H 226 SPRAYPACK
Product image (may differ)				
Spraying method	-		-	
Technology				
Drive				
Voltage	230 V / 50 Hz	230 V / 50 Hz	230 V / 50 Hz	230 V / 50 Hz
Heating power	0.6 kW	0.6 kW	1.3 kW	1.3 kW
Operating pressure, max.	250 bar, 25 MPa	250 bar, 25 MPa	250 bar, 25 MPa	250 bar, 25 MPa
Temperature control	20 - 60 °C	20 - 60 °C	20 - 60 °C	20 - 60 °C
Hose length	10 m	10 m	15 m	15 m
Weight	3.2 kg	-	18 kg	-
Power connection cable	4 m	4 m	6 m	6 m
Art. No.	2311659	2311852	2311660	2311853

 Small objects
up to 50 m²

 Residential
50 m² - 200m²

 Large residential
200 m² - 800m²

 Commercial
more than 800m²

 XVLP / HVLP

 AirCoat

 Airless

 Plaster spraying

 Piston pump

 Diaphragm pump

 Turbine







 Spiral pumps



 Battery

 Electric

 Petrol-driven

 TempSpray

	TEMPSPRAY H 326 BASE UNIT	TEMPSPRAY H 326 SPRAYPACK
Product image (may differ)		
Spraying method	-	
Technology		
Drive		
Voltage	230 V / 50 Hz	230 V / 50 Hz
Heating power	1.1 kW	1.1 kW
Operating pressure, max.	250 bar, 25 MPa	250 bar, 25 MPa
Temperature control	20 - 60 °C	20 - 60 °C
Hose length	30 m	30 m
Weight	23 kg	-
Power connection cable	6 m	6 m
Art. No.	2311661	2311854

	STEAMFORCE SPEED PRO
Product image (may differ)	
Drive	
Voltage	230 V / 50 Hz
Container volume	5,1 l
Vapour time, max.	68 min
Heating power	2750 W
Size of the steam plate	321 x 242 mm and 150 x 75 mm
Power connection cable	5 m
Hose length	5 m
Weight	7.5 kg
Art. No.	2418213

 Water and solvent-based paints,
lacquers, oils, separating agents

 Fire protection,
rust protection paints

 Structural waterproofing,
bituminous coatings

 Injection

 Synthetic resin lacquers,
PVC lacquers, 2K lacquers

 Emulsion and latex paints,
adhesives, sealants

 Filler

 Primers, fillers

 Exterior paints, roof coatings,
floor coatings, textured paint

 Plaster



Small objects
up to 50 m²



Residential
50 m² - 200m²



Large residential
200 m² - 800m²



Commercial
more than 800m²



XVL / HVLP



AirCoat



Airless



Plaster spraying



Piston pump



Diaphragm pump



Turbine



Spiral pumps



Battery



Electric



Petrol-driven



TempSpray

WAGNER ACCESSORIES

Perfectly equipped for every application

WAGNER offers innovative accessories which offer extended possibilities for the use of your system. These include the practical interior-fed paint roller for effective processing of emulsions indoors and outdoors as well as a wide range of accessories to make your daily work easier. On the following pages you will find a selection of our accessories.

THE FULL RANGE OF ACCESSORIES

You can find an overview of the entire range of accessories online at www.wagner-group.com or in our separate accessories brochure. Our service staff or specialist dealers will be happy to answer any specific questions you may have.



AILRESS SPRAYKITS

Perfectly tailored to every application

WAGNER SprayKits are specially adjusted accessory packages that expand the application range of your spraying unit.

ENAMEL KIT (DN4) FOR ALL SUPERFINISH PUMPS

ENAMEL KIT (DN4)

FOR SUPERFINISH PUMPS

(SF 21, SF 23, SF 33, SF 27, SF 31)

2406207

HP hose DN4, NPSM 1/4", max 27 MPa / 270 bar, 7.5 m

Vector Pro pistol

Nozzle extension, G-thread, 12.5 cm

FineFinish TT3 nozzle 308 (enamel)

FineFinish TT3 nozzle 412 (filler)

TipClean 200 ml

Plug-in filter, red, extra fine, 10 pieces

Hopper set 5 liters, M36 x 2



HEA KIT (DN6) FOR ALL PUMPS WITH 1/4" CONNECTIONS

HEA KIT (DN6)

FOR ALL PUMPS WITH 1/4" CONNECTIONS

(ALL SUPERFINISH AND PROSPRAY PUMPS, AS WELL AS THE POWERPAINTER 90)

2408212

HP hose DN6, NPSM 1/4", max. 27 MPa / 270 bar, 15 m

Vector Pro pistol

Nozzle extension, G-thread, 15 cm

HEA ProTip nozzle 517

HEA ProTip nozzle 311

TipClean 200 ml

Gun filter, white, medium, 10 pieces



EMULSION KIT (DN6) FOR ALL PUMPS WITH 1/2" CONNECTIONS

EMULSION KIT (DN6)

FOR ALL PUMPS WITH 1/2" CONNECTIONS
(PS 3.39 AND HEAVYCOAT PUMPS)

2406208

Transition fitting (F) NPSM 1/2" to (M) NPMS 1/4"

2x HP hose DN6

Double connector 1/4" NPSM

Vector Grip gun

Nozzle extension, G-thread, 12.5 cm

Nozzle extension, G-thread, 25 cm

HEA ProTip nozzle 519

TradeTip 3 Nozzle 427

TipClean 200 ml

2x adjustable wrench, 250 mm

Gun filter, white, medium, 10 pieces

Incl. matching adapter and 2x rolling fork spanners



EMULSION KIT (DN10) FOR PLASTCOAT HP 30

EMULSION KIT (DN10)

FOR PLASTCOAT HP30

(WITH HEA TECHNOLOGY, PC HP 30 CAN ALSO BE USED TO
APPLY EMULSION PAINTS WITH THE BEST SURFACE QUALITY).

2400684

HP hose DN10, max. 25 MPa / 250 bar, NPSM 3/8", 15 m

Vector Pro pistol

HEA ProTip nozzle 517

Adapter FM 1/2BSPP-3/8NPSM

Adapter FM 1/4 NPSM-3/8NPSM



FILLER KIT (DN10) FOR ALL PUMPS WITH 1/2" CONNECTIONS

EMULSION KIT (DN10)

FOR ALL PUMPS WITH 1/2" CONNECTIONS
(PS 3.39 AND HEAVYCOAT PUMPS)

2406209

Transition fitting (F) NPSM 1/2" to (M) NPSM 3/8"

HP hose DN10, NPSM 3/8", max. 25 MPa / 250 bar, 15 m

Double connector 3/8" NPSM to 1/4" NPSM

Airless gun AG 14, G-thread 1/4"

Nozzle extension, G-thread, 25 cm

TradeTip 3 Nozzle 335

TradeTip 3 Nozzle 439

TipClean 200 ml

2x adjustable wrench, 250 mm

Gun filter, white, medium, 10 pieces



2GUN KIT - CONNECTION OF UP TO THREE GUNS ON ONE DEVICE

2GUN KIT

CONNECTION OF UP TO THREE GUNS ON ONE DEVICE
(SF33, PS 3.31 upwards and HeavyCoat pumps)

2413598

Distributor adapter (for max. three guns)

Vector grip gun

HP hose DN6

Double connector NPSM 1/4"











ACCESSORIES – AIRLESS NOZZLES

The heart of the spraying process

Across all technologies – Airless, AirCoat, plaster spraying with worm pumps, HVLP or XVLP – nozzles and air caps play a decisive role in surface quality. In addition to the actual pump, they are the true heart of the spraying process. This is where the material is atomized and where the fineness of the droplet formation in the spray pattern is determined. The nozzle size also determines the quantity of material forced through the bore. Top-quality nozzles are a prerequisite for premium surface finishes in line with your professional standards.



	Water and solvent-based lacquers, lacquer paints, oils, separating agents		Synthetic resin lacquers, PVC lacquers, 2K lacquers		Primers, fillers
	Fire protection, rust protection paints		Emulsion and latex paints, adhesives, sealants		Exterior paints, roof coatings, floor coatings, textured paint
	Structural waterproofing, bituminous coatings		Filler		Plaster



Art. No.
553xxx

AIRLESS TRADETIP 3 NOZZLES – PERFECT AND DURABLE

The yellow standard nozzle offers a wide range of applications for processing primers, lacquers, varnish, emulsion paints, fire and rust protection paints up to airless filler.

Jet width (mm)*	Orifice size (inch)																								
	0.007	0.009	0.011	0.013	0.015	0.017	0.019	0.021	0.023	0.025	0.027	0.029	0.031	0.033	0.035	0.039	0.043	0.045	0.051	0.052	0.055	0.061	0.063	0.065	0.067
100	107	109	111	113	115	117																			
120	207	209	211	213	215	217	219	221	223	225	227	229	231	233	235		243			252		261	263		267
150	307	309	311	313	315	317	319	321	323	325	327	329	331	333	335										
190	407	409	411	413	415	417	419	421	423	425	427	429	431	433	435	439	443	445	451		455	461	463		467
225		509	511	513	515	517	519	521	523	525	527	529	531	533	535	539	543	545	551		555	561		565	
270		609	611	613	615	617	619	621	623	625	627	629	631	633	635	639	643		651		655	661		665	
300					715	717	719	721	723	725			731		735										
330				813	815	817	819	821	823	825	827		831												
385							919																		
Flow rate (l/min)**	0.19	0.34	0.45	0.68	0.91	1.17	1.47	1.78	2.15	2.53	2.95	3.44	3.89	4.42	4.99	6.20	7.52	8.24	10.58						
Filter	red			yellow			white									green									



Art. No.
554xxx

HEA PROTIP NOZZLES – UP TO 55 % LESS OVERSPRAY

The new WAGNER HEA ProTip airless nozzle provides a perfect surface finish at reduced spraying pressure. Compared to standard airless technology the spray pattern is gently feathered and free from edge strips.

		Orifice size (inch)							
		0.011	0.013	0.015	0.017	0.019	0.021		
Jet width (mm)*	120	211	213					20	Spray angle in °
	150	311	313					30	
	190	411	413	415	417		421	40	
	225			515	517	519	521	50	
	270			615	617	619	621	60	
Flow rate (l/min)**		0.45	0.68	0.91	1.17	1.47	1.78		
Filter		red		yellow	white				



Art. No.
554xxx

AIRLESS TRADETIP 3 FINEFINISH NOZZLES

Top paint nozzle with optimized third-generation properties. With double special core for ultra-fine droplet formation and exceptionally high-quality surfaces, even in low pressure ranges. FineFinish nozzles are coloured purple.

		Orifice size (inch)					
		0.008	0.010	0.012	0.014		
Jet width (mm)*	120	208	210	212	214	20	Spray angle in °
	150	308	310	312	314	30	
	190	408	410	412	414	40	
	225		510	512	514	50	
Flow rate (l/min)**		0.26	0.42	0.6	0.79		
Filter		red					

* Spray width (mm) at approx. 30 cm distance from the object and 100 bar pressure, with synthetic resin paint, 20 DIN seconds

** Measured with water at 120 bar pressure



AIRLESS NESPRI TWIN TIP NOZZLES

For mist-free spraying: NESPRI TwinTip nozzles have two nozzle orifices one directly above the other – For a perfect spray pattern with high material throughput even in low pressure ranges. Guaranteed mist-free thanks to the use of the NESPRI spray device in combination with the NESPRI TwinTip and NESPRI paints from Caparol. Different sizes are available to adapt ideally to the relevant environment.

Art. No. 1009xxx

Orifice size (inch)

Jet width (mm)*	0.013	0.021	0.023	0.027	Spray angle in°
100		215			20
110	213***				20
130		316	317	319	30
Filter	white				

*** Mono nozzle for trimming jobs



AIRLESS STANDRAD FAN NOZZLES

Airless standard flat jet nozzle are especially suitable for painting applications, but can be used also for high viscosity materials. They are ideal for the fast processing of large quantities of material. The high-quality nozzles are robust and suitable for all common Airless guns.

Note: Airless flat spray nozzles must be used with contact protection for flat spray nozzles (97294) and seal (43052).

Art. No. 90xxx

Orifice size (inch)

Jet width (mm)*	0.007	0.009	0.011	0.013	0.015	0.017	0.019	0.021	0.023	0.025	0.027	0.030	0.031	0.035	0.039	0.043	0.051
90			111		115												
100			211	113	215												
120			311	213		217			223	225				235			
150		209		313		317	219	221			227					243	
160	407	309			315		319										
190	507	409				417	419	421	423	425							
215		509	411	413	415								431				
225		609	511			517					427		531	435			
250					515			521	523	525	527						
270			611	513	615		519			625	627		631	535		543	552
300				613	715	617	619		623			629		635			
330						717	719	621	723		827						
385				813	815			821	823	825							
400							819										
480															839		
Flow rate (l/min)**	0.19	0.34	0.49	0.68	0.91	1.17	1.47	1.78	2.15	2.53	2.95	3.44	3.89	4.99	6.2	7.52	11.0
Filter	red		red/yellow		yellow		yellow/white		white			green					

* Spray width (mm) at approx. 30 cm distance from the object and 100 bar pressure, with synthetic resin paint, 20 DIN seconds
** Measured with water at 120 bar pressure

Water and solvent-based lacquers, lacquer paints, oils, separating agents

Fire protection, rust protection paints

Structural waterproofing, bituminous coatings

Synthetic resin lacquers, PVC lacquers, 2K lacquers

Emulsion and latex paints, adhesives, sealants

Filler

Primers, fillers

Exterior paints, roof coatings, floor coatings, textured paint

Plaster

ACCESSORIES – AIRLESS

AIRLESS GUN VECTOR INFINITY Art. No.

Vector Infinity with G-thread 1/4", incl. TradeTip 3 nozzle holder, 34.5 MPa (345 bar) with 2-finger trigger and adaptable hand grip 538085

Small grip, for customization to any hand, for Vector Infinity 538264

Medium grip, for customization to any hand, for Vector Infinity 538265

Large grip, for customization to any hand, for Vector Infinity 538266



Vector Infinity is - the premium gun

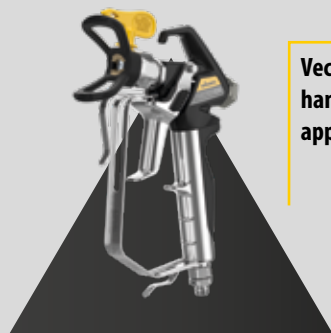

Vector Grip - fits perfectly in the hand and is suitable for heated applications

AIRLESS GUN VECTOR GRIP Art. No.

Vector Grip with G-thread 1/4", incl. TradeTip 3 nozzle holder, 25 MPa (250 bar) with 2- and 4-finger trigger and medium-sized grip 538043

Small grip, for customization to any hand, for Vector Grip 538228

Medium grip, for customization to any hand, for Vector Grip 538229

Large grip, for customization to any hand, for Vector Grip 538230

AIRLESS GUN VECTOR PRO Art. No.

Vector Pro with G-thread 1/4", incl. TradeTip 3 nozzle holder, 25 MPa (250 bar) with 4-finger trigger 538040

Vector Pro with G-thread 1/4", incl. TradeTip 3 nozzle holder, 25 MPa (250 bar) with 2-finger trigger 538041

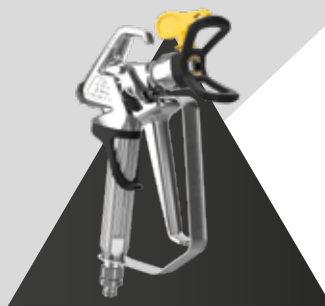

Vector Pro - the entry level spray gun

AIRLESS GUN AG 14 WITH 4-FINGER TRIGGER Art. No.

Airless gun AG 14, G-thread 1/4", 27 MPa (270 bar), incl. TradeTip 3 nozzle holder 0502081A



AG 19 - is particularly suitable for highly viscous materials

**25 MPa
(250 bar)**

**53 MPa
(530 bar)**

FILLER AIRLESS GUN AG 19 WITH 4-FINGER TRIGGER Art. No.

Airless gun AG 19, 25 MPa, G-thread 3/8", incl. TradeTip 3 nozzle holder 2341127

HIGH-PRESSURE AIRLESS GUN AG 19 WITH 4-FINGER TRIGGER Art. No.

Airless gun AG 19 with G-thread 1/4", 53 MPa (530 bar) 2343778

HIGH PRESSURE HOSES	Art. No.
DN3, NPS (M) 1/4", 7.5 m	9984583
DN3, NPS (M) 1/4", 10 m	2301052
DN4, NPS (M) 1/4", 7.5 m	9984573
DN4, NPS (M) 1/4", 10 m	2302374
DN6, NPS (M) 1/4", 15 m	9984574
DN6, NPS (M) 1/4", 30 m	9984575
DN10, PS (M) 3/8", 15 m	2336583*
DN10, PS (M) 3/8", 30 m	2336584*
DN13, NPS (M) 1/2", 15 m	2336585*
DN 19, NPS (M) 3/4", 15 m	2336586*

* Max. 25 MPa (250 bar)

High-pressure hoses are available in different lengths and internal diameters. The perfect hose for every application

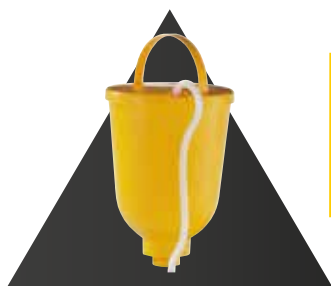
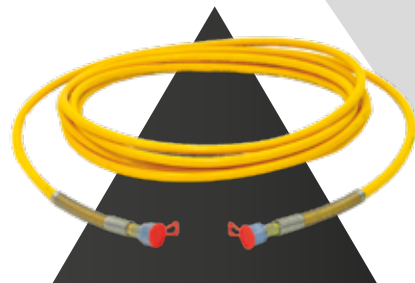

5 liter hopper – perfect for small volumes of paint

HOPPER	Art. No.
Hopper 20 liter, M36x2, for SuperFinish	341266
Hopper 5 liter, M36x2, for SuperFinish	341265
Hopper 5 liter, with TopClean, for SuperFinish	341268
Hopper, 5 liter, for PowerPainter 90 Extra	2423122
Hopper, 5 liter, for ProSpray 3.20, 20, 3.21, 3.25 Skid	704-453
Hopper 3.7 liters, for SuperFinish 21 Pro	2444212

SUCTION SYSTEMS	Art. No.
Container suction system, incl. C-coupling adaptor	349907
Reduction adaptor B- to C-coupling	9991651
Blanking plug for C coupling	97305
Container Connector, for HeavyCoat, for direct suction of the material out of the large volume container	2383128
Container Connector, for SF 27/31/33	2371930
Large volume containers (100 l)	2309956
Large volume container, incl. sack support and roller press	2309960
Sack support incl. guide rail for roller, for large volume container	2323178
PumpRunner (only for rigid suction system)	2306987
Suction system, for SF 23 Plus, incl. PumpRunner	2342879

PumpRunner – for clean and easy transportation of the pump



OTHER**Art. No.**

Hose reel HR30, M16x1.5, for 30 m HP hose, usable for SF23 Plus / SF 27 / SF 31 (without hose)	341910
Hose reel HR30, 1/4" NPS, for 30 m HP hose, usable for SF 33 (without hose)	2392523
Hose reel HR45, incl. 30 m HP hose DN6, for all diaphragm and piston pumps	341912
Hose whip DN10, max. 25 MPa, NPSM 3/8", 2.5 m	2336582

Hose reel – perfect hose management for optimum handling

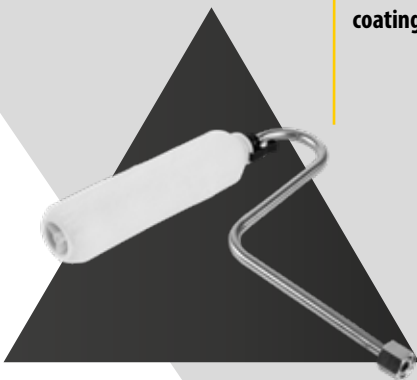

Airless paint roller - efficient coating with paint rollers

**PAINT ROLLERS****Art. No.**

Inline Roller IR 100 complete, incl. dosing handle, extension, 7.5 m high-pressure hose, scaffold hook and paint roller	345010
Inner-Feed Roller, 23 cm	2418370
Inner-Feed Roller, incl. extension (0.9 m)	2420499
SprayRoller bracket, 25 cm	2411697
SprayRoller bracket, incl. extension (0.9 m)	2420497
SprayRoller hanger, 23 cm	2418371
SprayRoller cage, incl. extension (0.9 m)	2420496
Nozzle extension, 0.9 m	2420538

OTHER**Art. No.**

Pressure gauge combination cpl. HEA (MPa)	2383995
Distributor adapter for max. 3 guns	2304430
Hose connector A 1/4" NPSM - A 1/4" NPSM	34038
Connector I 1/4" NPSM - A 3/8" NPSM	179732
SpeedShield	538905

SpeedShield – Trimming and cutting in without masking. Supplied without nozzle and extension

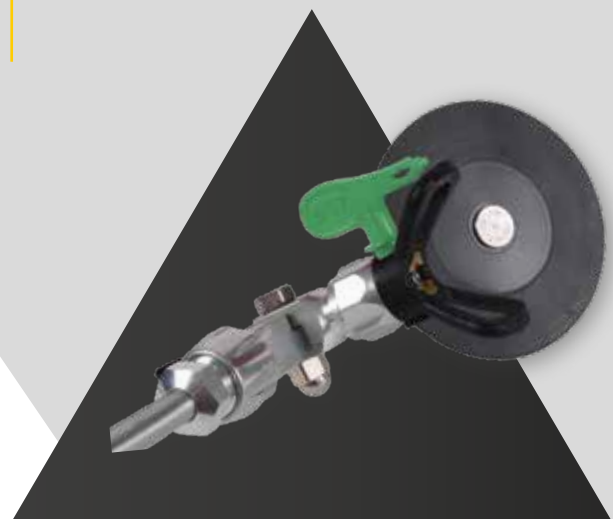

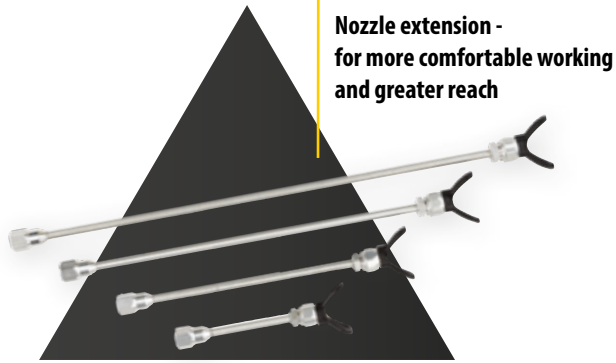

**Nozzle extension -
for more comfortable working
and greater reach**

NOZZLE EXTENSIONS, G-THREAD **Art. No.**

Nozzle extension, with holder without nozzle, 12.5 cm	2418853
Nozzle extension, with holder without nozzle, 25 cm	2418854
Nozzle extension, with holder without nozzle, 50 cm	2418855
Nozzle extension, with holder without nozzle, 75 cm	2418856
Nozzle extension, with holder without nozzle, 90 cm	2418862
Nozzle extension, with holder without nozzle, 180 cm	2418863

SHUT-OFF VALVE **Art. No.**

ClearSpray valve **Art. No.** 2459770
Thread sizes: Inside G 7/8", outside G 7/8"

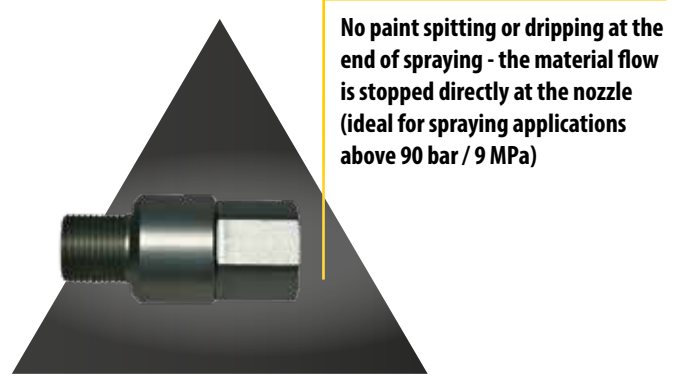

**No paint spitting or dripping at the
end of spraying - the material flow
is stopped directly at the nozzle
(ideal for spraying applications
above 90 bar / 9 MPa)**



**TipClean - easy cleaning and
storage of your airless tips**

CLEANING / STORAGE **Art. No.**

TipClean, container incl. special cleaner, 200 ml	2400214
EasyClean Cleaning and corrosion protection 1 l	2412656
EasyGlide, special oil, 118 ml	508619

GUN FILTER **Art. No.**

Gun filter, red, extra fine, 180 MA, 0.084 mm MW, 10 pcs.	97022
Gun filter,, yellow, fine, 100 MA, 0.14 mm MW, 10 pcs.	97023
Gun filter, white, medium, 50 MA, 0.31 mm MW, 10 pcs.	97024
Gun filter, green, coarse, 30 MA, 0.56 mm MW, 10 pcs.	97025

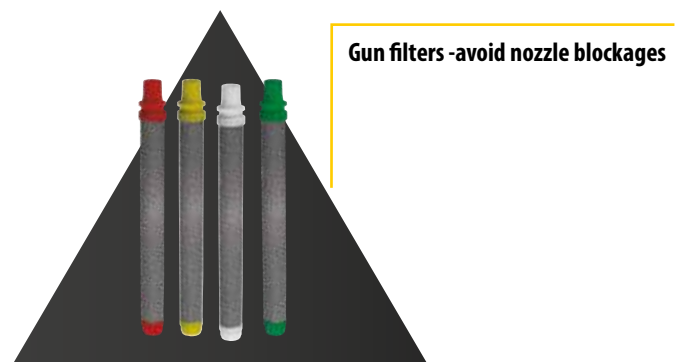

Gun filters -avoid nozzle blockages

PERFECT HOSE HANDLING

These helpers improve hose management

With our flexible swivel joints and our hose reels, any high-pressure hose can be wound and unwound quickly and easily. When spraying, the FlexTwist Z swivel joint offers a comfortable gun position and ensures fatigue-free working.

FLEXTWIST Z

Art. No.

FlexTwist Z - external thread 1/4" internal thread 1/4" 2454974

Accessories suitable for connecting airless gun with airless hose

Reversible: With three axes that can be rotated 360 degrees

Improved ergonomics: the airless gun can be held easily at any angle

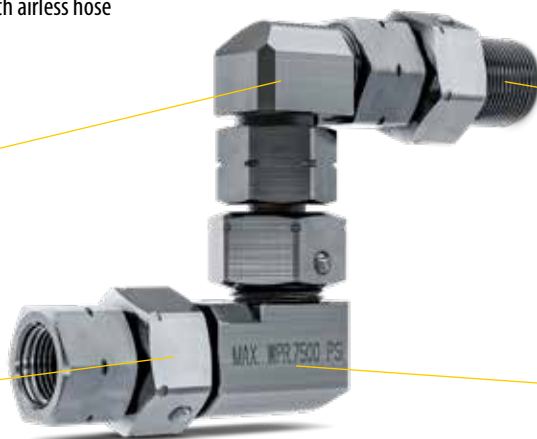

Thread size: Outside and inside 1/4"

Easy tube handling: for fatigue-free spraying with minimal strain on the wrist

FLEXTWIST S

Art. No.

FlexTwist S - external thread 1/4" internal thread 1/4" 2454968

FlexTwist S - external thread 3/8" internal thread 3/8" 2454969

Accessories suitable for connecting airless gun with hose or hose with spray gun

Flexible: 360 degree rotatable axis

Easy winding and unwinding: no twisting of the airless hose



Thread sizes: 1/4 and 3/8"

Makes your job easier: improved hose handling

ACCESSORIES – AIRCOAT

for wood and metal craft

Brilliant surfaces with AirCoat: The soft atomization guarantees brilliant surfaces and thus ensures perfect painting results.



AIRCOAT NOZZLES ACF 3000

The dome-shaped geometry and high-tech honing methods during manufacture ensure extremely fine atomization with low energy consumption (material pressure). For a long service life and low wear and tear, the nozzle is made from resistant hard metal. The WAGNER AirCoat nozzle ensures brilliant surface finishes: An even spray pattern and extremely gentle graduated borders are guaranteed. This applies to both small and large quantities of atomised air.

Art. No.
379xxx

Orifice size (inch)

Jet width (mm)*	Orifice size (inch)									Spray angle in °
	0.007	0.009	0.011	0.013	0.015	0.017	0.019	0.021	0.023	
55	107		111	113	115					10
100	207	209	211	213	215	217	219	221		20
145	407	309	311	313	315	317	319			30
195		409	411	413	415	417	419	421	423	40
250		509	511	513	515	517	519	521		50
300		609	611	613	615	617	619	621	623	60
400			811	813	815	817	819	821	823	80
Filter	red		red/yellow		yellow		yellow/white	white		



AIRCOAT PRE-ATOMIZATION NOZZLES ACF 3000 PLUS

AirCoat pre-atomization nozzles provide extra fine atomization even with low inlet air pressure. This is especially important for processing water- or solvent-based paints. Using a pre-atomization nozzle allows you to work with less material and air quantity. There is significantly less overspray and material consumption decreases. Compared to the standard AirCoat nozzle the material is pre-atomised directly at the outer edge of the nozzle. The result: an especially even and soft spray pattern.

Art. No.
321xxx

Orifice size (inch)

Jet width (mm)*	Orifice size (inch)								Spray angle in °
	0.008	0.010	0.012	0.014	0.016	0.018	0.020	0.022	
100	208	210	212	214	216	218			20
145	308	310	312	314	316	318	320		30
195	408	410	412	414	416	418	420	422	40
250	508	510	512	514	516	518			50
300		610	612	614	616	618	620	622	60
Filter	red		red/yellow		yellow	yellow/white	white		

* Spray width (mm) at approx. 30 cm distance from the object and 10 MPa (100 bar) pressure, with synthetic resin paint, 20 DIN seconds

** Measured with water at 12 MPa (120 bar) pressure

AIRCOAT MATERIALS

Only for AirCoat nozzles,
ACF 3000 & ACF 3000 Plus

 Water and solvent-based lacquers, lacquer paints, oils, separating agents

 Synthetic resin lacquers, PVC lacquers, 2K lacquers

 Primers, fillers

 Fillers, rust protection paints

 Fire protection, rust protection paints

 Corrosion protection

AIRCOAT GUN AC 4500

Art. No.

AirCoat gun AC 4500, incl. blue air cap and holder	2368269
AirCoat gun AC 4500, incl. green air cap and holder	2368270
AirCoat gun AC 4500, incl. red air cap and holder	2368271

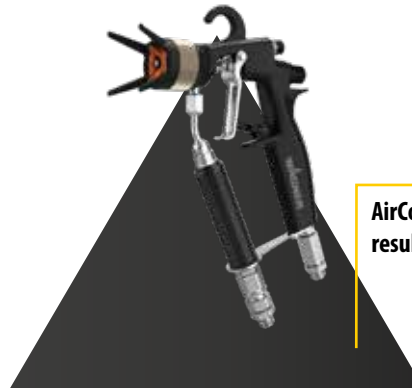

AirCoat AC 4500 for perfect surface results



AirCoat AC 4600 for ambitious, comfortable painting work

AIRCOAT PISTOLE AC 4600

Art. No.

AC 4600 Professional, incl. blue air cap and holder	394156
AC 4600 Professional, incl. green air cap and holder	394158
AC 4600 Professional, incl. red air cap and holder	394157

AIRCOAT GUN ACCESSORIES

Art. No.

Air cap blue, for water-based materials (01)	394911
Air cap red, for solvent-based materials (02)	394910
Air cap green, for water-based materials and solvent-based materials (03)	394912
Union nut, complete (04)	394921

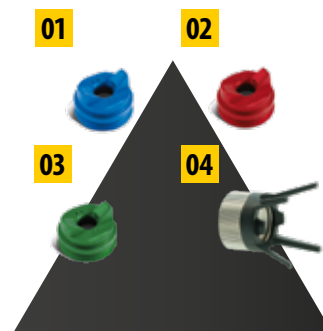

Various air caps for different applications

ACCESSORIES – PLASTCOAT

CONTINUOUS MIXER

Art. No.

PlastMix 15, with steel mixing tube	2348669
PlastMix 15, with PUR mixing tube	2359240



Continuous mixer for dry materials

PlastGuard longlasting - to protect the device and for optimum storage



ACCESSORIES FOR PLASTCOAT HP 30

Art. No.

PlastGuard longlasting pump protector, 5 l	2399960
PlastCoat HP 30 emulsion set	2400684

Cleaning balls – for cleaning out hoses and avoiding nozzle blockages

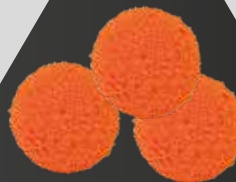

CLEANING AND STORAGE

Art. No.

Brush with handle and cap	9100095
Bottle brush for cleaning interior of outlet unit and spraying lance	342329
Cleaning adapter M27GK	342241
Cleaning brush, 280 to 420 mm long	348959
Cleaning ball DN16	2402355
Cleaning ball DN19	342330

Bag processing table – for the convenient emptying of bagged goods

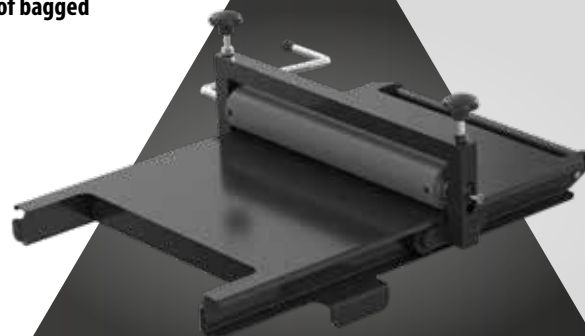

SUPPORT TABLE INCL. ROLLER PRESS

Art. No.

Support table, for PC 830	2318389
Support table, for PC HP 30	2389048

Current prices and further information about our products can be found here:
go.wagner-group.com/produkte



Contents, prices and specifications of 01/2024. All specifications are subject to change. Reproduction is prohibited without the consent of J. Wagner GmbH. Current general terms and conditions of the WAGNER-Group can be found on www.wagner-group.com.

BE UNSTOPPABLE!

VISIT US AT

